

# Food Machinery and Solutions by

# scansteel<sup>®</sup> foodtech

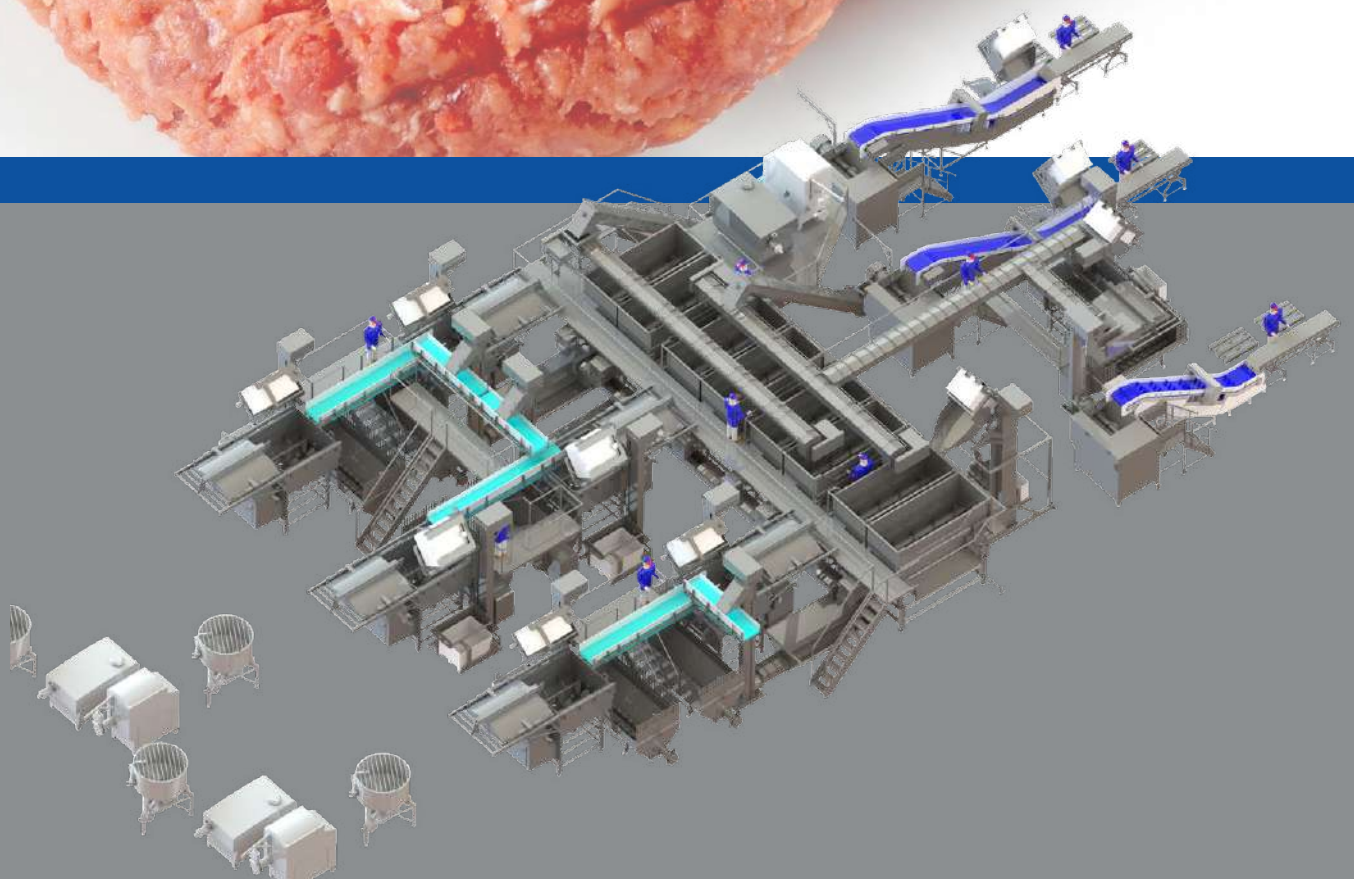

scansteel foodtech A/S is among the leading companies, designing, engineering, manufacturing, installing and servicing single machines and equipment as well as complete processing lines for the global food industries. scansteel foodtech A/S focuses and specializes within the following industries; meat- and poultry preparation, cheese preparation as well as convenience and fast food preparation industries.

Our core machinery competences are within grinders for fresh and frozen meat, mixers, vacuum mixers, pumps all applications, pump- and hopper fed emulsifiers, batching and weighing stations and silo systems for all types of heavy duty food applications.

scansteel foodtech A/S' portfolio of standard food preparation machines and equipment comprises a total of approximately 140 standard machines and equipment.

In addition to our standard range of food preparation machines and equipment scansteel foodtech A/S develops individual tailor made machines and equipment in co-operation with our customers.

Our food processing lines can be delivered with- or without Line Control Systems, with- or without recipe formulation software, uploading of data to customers' existing ERP systems and MCC's.

scansteel foodtech A/S is a 100% privately owned, Danish company (Europe, Scandinavia). scansteel foodtech A/S resides in the former 10.450 m<sup>2</sup> Wolfking® domicile in the city of Slagelse 1 hour from Copenhagen airport.

Feel free to contact scansteel foodtech A/S for a mutual conversation concerning any food preparation processing need you may have, now or in the future.



*View over scansteel foodtech® final assembly hall.*

# Table of Contents

Introduction .....	2
Food Industry Products .....	5-6
Grinders - Single Worm .....	7
MG 200, MG 250 & MG 225 .....	8-10
MG 330 .....	11
MG 400 & MG 400 Heavy Duty .....	12-13
SuperGrind 400/260 .....	14-15
Grinders - Double Worm .....	17-20
Mixers .....	21-28
Defrosting .....	29-30
Tumblers / Massagers .....	31
Pumps .....	32
SuperPump .....	32-35
ContiPump .....	36-38
Emulsifiers – Overview .....	39
scanEmul 175 - Hopper fed .....	40
scanEmul 175 - Screw hopper fed .....	41
scanEmul 175 - Pump fed .....	42
Quadrocut 225 .....	43
QuadroCutVac 225 .....	44
QuadroCutVac 225 - TemBi .....	45-46

Danish quality  
equipment conceived,  
engineered, and  
manufactured in  
Denmark

# Table of Contents

Meat-bone Separators/Deboners/Desinewers.....	47
Gravy Production Systems.....	48
scanGravy with Ytron Powder Dispenser - Heavy Duty Applications.....	49
scanGravy with Venturi System.....	49
Storage & Batching.....	50
Silo Systems.....	50-51
Swing Loader Systems.....	52-54
Product Transfer Equipment.....	55
Infeed Systems for Grinders - Frozen Blocks.....	55-56
Infeed Systems for Grinders - Fresh Raw Meat Materials.....	57-58
Discharge Systems for Grinders.....	59-60
Screw Conveyors.....	61-62
scanGiraff.....	63-65
scanLift.....	66-69
Pallet Inverter.....	70
scanSwing.....	71
Line Control System.....	72
Layout.....	73-76
Global Team.....	77-84

scansteel foodtech A/S specializes in machinery, equipment, and complete processing lines.

## A Emulsified Sausages



## B Ground Sausages



## C Hamburgers & Patties

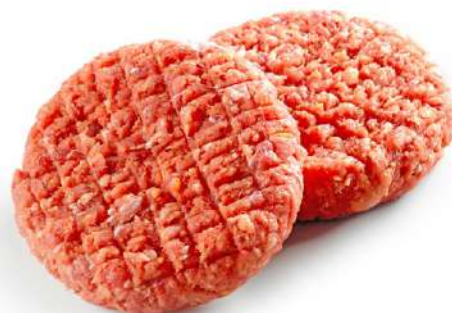

**D** Formed Ground Convenience Foods



**E** Ground Meat; Beef, Pork, Chicken in Trays & Bulk



**F** Processed Meats



## GRINDERS – SINGLE WORM

Over the years, the scansteel foodtech Group has conquered the position as THE supplier with the world's widest and most comprehensive grinder programme. scansteel foodtech A/S delivers, among others, the following grinder programme:

- Cabinet Grinders ranging from Ø200 mm – Ø550 mm (Ø8" – Ø22") – 22 kW – 200 kW (type name: MG).
- Open Cabinet Grinders ranging from Ø200 mm – Ø550 mm (Ø8" – Ø22") – 22 kW – 200 kW (type name: MG Low).
- SuperGrind series ranging from Ø400 mm – Ø550 mm.



### SINGLE WORM/AUGER GRINDERS:

SuperGrind SG 400/260	110 - 160 kW
MG 400 Super Heavy Duty, Brutalis	160 - 200 kW
MG 400 Heavy Duty	132 - 160 kW
MG 400	90 - 110 kW
MG 330	75 - 90 kW
MG 250	55 kW
MG 225	37-45 kW
MG 200	30 kW

### FEATURES:

- Constructed in stainless steel AISI 304.
- Grinders from Ø200 mm – Ø550 mm.
- Grinding capacities from 2000 – 40,000 kg/hour.
- Large hopper infeed area preventing bridge building.
- Low noise level.
- Low energy consumption.
- 75 kW – 250 kW motor.
- 1 or 2 units dismantling crane.
- Heavy Duty construction.

## GRINDER – SINGLE WORM: MG 200 & MG 250

The scansteel foodtech® MG 200 & MG 250 grinders are specially designed for fresh meat and fresh meat raw materials as well as for pre-broken/crushed frozen blocks.



*Infeed hopper secured by trip wire. When safety devices have been triggered, they will stop the machine after maximum of 4 (four) seconds.*

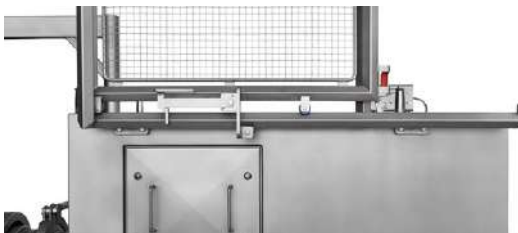

*Top picture: Safety guard for platform shown in running position.  
Bottom picture: Safety guard for platform shown in open/cleaning/inspection position.*

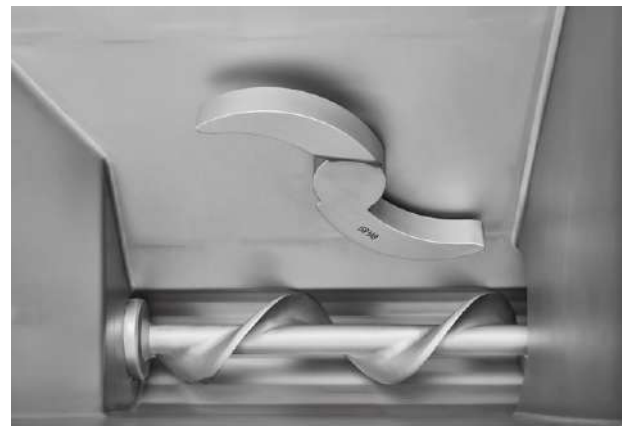

*Stirring/feeding device. To secure continuous infeed of difficult/sticky meat raw material at the grinder worm/auger.*



# Grinders

## GRINDER – SINGLE WORM: MG 200 & MG 250



Top picture: Assembly of SINGLE knife set including grinding worm/auger.

Bottom picture: Assembly of DOUBLE knife set including grinding worm/auger.



Accessory/cleaning trolley with space for all loose grinder parts.

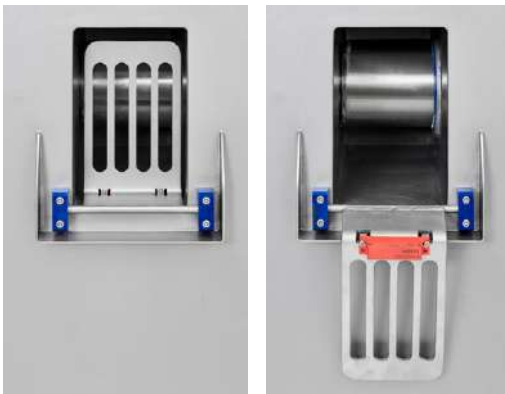

A prime example of scansteel foodtech® hygienic design is given by the hygienic zone positioned between the worm/auger and the gear box. Hygienic zone shown in running position (closed) and in cleaning/inspection position. When opened, the grinder cannot be started until the guard has been positioned in closed position.

MG 200 shown with back panel open. All stainless steel construction, including bottom frame.



## GRINDER – SINGLE WORM: MG 225 - FOR FRESH RAW MATERIAL AND FROZEN BLOCKS

The scansteel foodtech® MG 225 Frozen Block Grinder is incredibly strong despite its compact size and it combines efficient processing with quality grinding. The MG 225 is specifically designed to grind whole frozen blocks and is perfect for grinding of fresh meat raw material as well. The MG 225 Frozen Block Grinder is equipped with a 45 kW motor, and it maintains a low operating cost and a low energy consumption for daily production. But without compromising on scansteel foodtech's well-known high quality standards, such as high hygienic design, operating safety, and performance.



The scansteel foodtech®  
MG 225 Frozen Block Grinder



Operator panel



Top view of infeed hopper of the MG 225



Accessory/cleaning trolley with space for all loose grinder parts.



The scansteel foodtech® MG 225 is designed to be fed by either a belt conveyor or a lifting, here shown being fed by the scanLift SC 350 with 220 L trolley.

## GRINDER – SINGLE WORM MG 330

The scansteel foodtech® MG 330 is equipped with either 75 kW or 90 kW electrical motor depending on specific grinding application(s). The MG 330 grinder is incredibly strong and reliable for both frozen blocks of meat raw material of any type as well as for certain bone-in products plus fresh meat raw materials. It comes with either a fixed or a loose pre-cutter depending on the grinding application.



*Infeed hopper shown from top view. Please note the grinding worm/auger with the sharp knife edge, designed to grab and feed both frozen blocks and fresh meat raw materials.*

*MG 330 shown with standard operator panel with MINIMAL electrical/ electronic parts. Please note the safety guard is in open/disassembly position.*



*MG 330 shown with optional flange mounted extension infeed hopper and trip wire.*

*MG 330 shown in mounting position. The cleaning trolley for worm/auger shows/ indicates how to dismount the worm/auger, while avoiding heavy lifts/pulls.*

# Grinders

## GRINDER – SINGLE WORM: MG 400 & MG 400 HEAVY DUTY

The scansteel foodtech® MG 400 & MG 400 Heavy Duty grinders are incredibly strong and reliable grinders for both frozen blocks of meat raw material of any type as well as for certain bone-in products plus fresh meat raw material. They come with either a fixed or a loose pre-cutter depending on the grinding application.



MG 400 Heavy Duty shown in disassembled position and with all loose parts positioned on accessory/ cleaning trolley for inspection and cleaning prior to assembly.



Infeed hopper shown from top view.



Hygienic zone shown in 3 (three) positions: running position (closed) and cleaning position shown from both angles.

scansteel foodtech® MG 400 Standard LOW and MG 400 Heavy Duty LOW. Grinder without cabinet. Shown with scansteel foodtech® hydraulic knife tensioning system.



# Grinders

## GRINDERS – SINGLE WORM: MG 400 & MG 400 HEAVY DUTY



Optional Extra, Example Only:  
scansteel foodtech® worm/auger.

Please note: Worm/auger is not  
included in the price of cleaning  
trolley for worm/auger.



Cleaning trolley for worm/auger shown  
without worm/auger.



Cleaning trolley for worm/auger shown after  
the worm/auger has been removed from  
grinder.

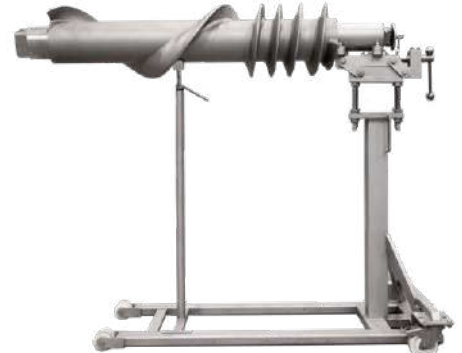

Cleaning trolley for worm/auger shown with  
safety shaft mounted for cleaning, inspection,  
and transport.



MG 400 worm/auger.



Heavy Duty designed worm/auger with sharp knife edge on hopper part of worm/auger to grab frozen blocks.



scansteel foodtech® accessory/cleaning trolley  
shown with all loose parts for inspection and  
cleaning.



# Grinders

## SUPERGRIND 400/260 & SUPERGRIND 550/310



*SuperGrind 400/260 shown fully assembled, ready for production. Shown with safety inlet cage which prevents meat raw material, such as frozen blocks, from being ejected during feeding of the grinder.*

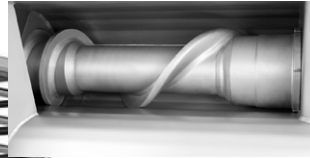

*Worm/auger shown mounted in the SuperGrind 400/260 cabinet, top view.*



*SuperGrind 400/260 shown with all side panels dismantled, side view. Designed for easy access at maintenance and inspection. The automatic greasing system for main bearing and front bearing is also shown.*

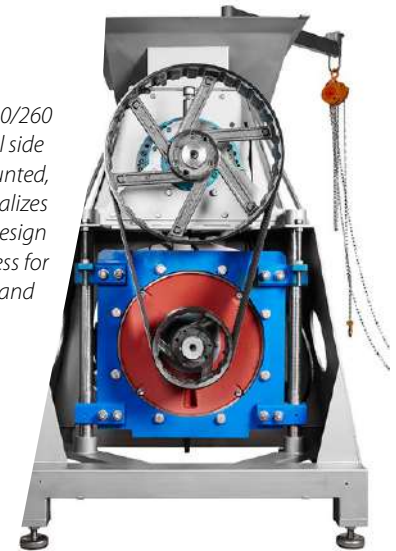

*SuperGrind 400/260 shown with all side panels dismantled, rear view. Visualizes perfectly the design with easy access for maintenance and inspection.*

Globally, the scansteel foodtech® SuperGrind 400/260 & 550/310 are probably the toughest and most Heavy Duty “Work Horses” among meat raw material grinders.

- Entire beef bones - all types including femur bones.
- Entire pork bones - all types including femur bones.
- Poultry bones – all types.
- Fish bones – all types.
- Pre-broken bones.
- Soft meat raw material.

*The Heavy Duty design of worm/auger for SuperGrind 400/260*

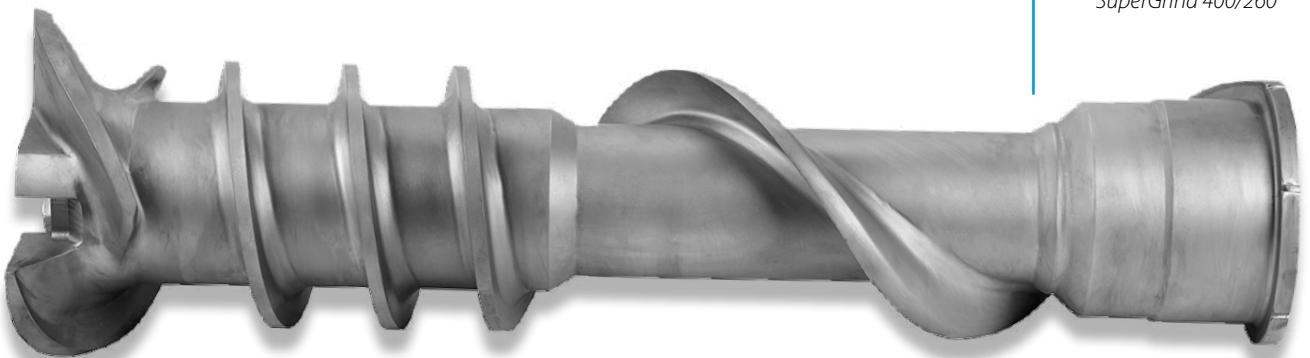

## SUPERGRIND 400/260 & SUPERGRIND 550/310



Cabinet without worm/auger showing the flights of the lining.



Front end of SuperGrind 400/260 shown disassembled, with worm/auger in place, ready for mounting of 3-bladed cut-knife. Cut-knife recessed into the worm/auger.



Front end of SuperGrind 400/260 shown with worm/auger and 3-bladed cut-knife assembled.



The SuperGrind 400/260 equipped with 90 kW - 160 kW motor and The SuperGrind 550/310 can be equipped with 160 kW - 250 kW motor.

The SuperGrind 400/260 & 550/310 can be equipped with single or double knife set.

SuperGrind 400/260 with knife set and front end fully assembled. Automatic greasing of front end bearing is shown as well.

# Grinders



- SuperGrind 550/310 worm/auger.



- SuperGrind 400/260 worm/auger.



- MG 400 worm/auger.



- CG 300 grinding worm/auger.



- CG 300 feeding/breaking worm/auger.

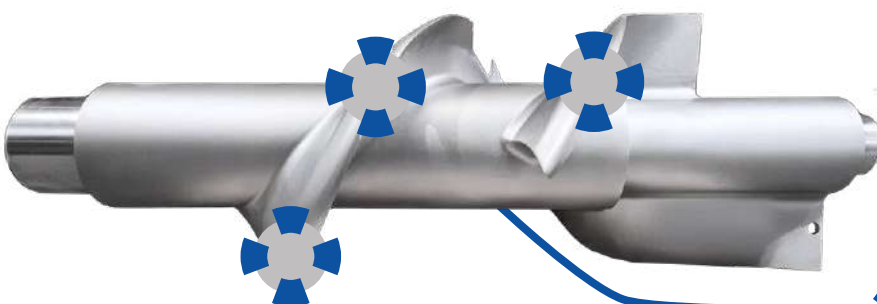

- CG 400 shark tooth worm/auger

For more information, please contact us!



# Grinders - Double Worm

## DOUBLE WORM COMBIGRIND CG 225 / CG 300 / CG 300 HEAVY DUTY / CG 400 – THE BEAST

These truly unique and universal grinders provide first-class grinding results, fully comparable with and even surpassing those of conventionally specialised grinders for fresh, tempered, or deep-frozen blocks without changing anything but the incoming raw material to be ground, coarsely or finely, as required. scansteel foodtech® CombiGrind Grinders from Ø160 mm – Ø400 mm (type name: CG).

CombiGrind CG 400  
– The Beast



### DOUBLE WORM/AUGER GRINDERS:

CombiGrind 400 Heavy Duty, The Beast	22 + 110 - 200 kW
CombiGrind 330 Heavy Duty	22 + 110 - 132 kW
CombiGrind 300 Heavy Duty	22 + 90 - 132 kW
CombiGrind 300	22 + 90 kW
CombiGrind 225	15 + 75 kW

High performance grinding within a wide capacity range is achieved through a low-tolerance, rigid design with smoothly shaped worms, hand-forged, welded, and ground superfinely by skilled Danish craftsmen combined with the smooth surfaces of a high precision CNC milling lining.



# Grinders

## DOUBLE WORM COMBIGRIND CG 225 / CG 300 / CG 300 HEAVY DUTY / CG 400 – THE BEAST



### HYGIENIC ZONE

A prime example of scansteel foodtech® hygienic design is given by the two hygienic zones – one positioned between each of the worms/augers and one between the gear boxes.

Top picture: Details of the two unique hygienic zones for both top/feeding worm and bottom/grinding worm. This unique feature physically prevents cross contamination. Protected by safety grill and safety switch, which will stop the motor in three to four seconds from activation to full stop.



The electrical panel is embedded into the machine cabinet. The electrical panel can swing away to grant full access to the interior of the machine at maintenance, etc.

## COMBIGRIND CG 225 / CG 300 / CG 300 HEAVY DUTY / CG 400 – THE BEAST

CombiGrind CG 300 shown with automatic start/stop of grinder by level sensors built into front legs. CombiGrind CG 300 shown with 300 L extension hopper, which will be designed according to customer request and to be quoted separately.



Fresh soft meats as well as tempered or hard frozen blocks are efficiently processed jointly or separately without changing any mechanical components due to the ingenious design of hopper, transfer area between the worms/augers combined with efficient fixation of the frozen blocks. Narrow tolerances eliminate backwash, fines, or smearing.



Operator control with easy-to-understand push button operation of start, stop, and emergency. Pre-setting of worm/auger speeds and programming functions with logically designed graphics on the touch panel. Programmes with fixed settings for various products can be keyed in with password protection. The scansteel® scanControl function can be set to optimize the feeding worm/auger speed in relation to the grinding worm/auger, thus reducing grinding capacity flow fluctuations.

## COMBIGRIND CG 225 / CG 300 / CG 300 HEAVY DUTY / CG 400 – THE BEAST



*Removal of breaker worm/auger and grinding worm/auger. CombiGrind CG 400 – The Beast*

Easy and efficient cleaning of both feeding worm/auger and grinding worm/auger, which can both be easily disassembled and removed together with other grinding tools by means of the included tool trolleys. Hole plates are easily removed and replaced during production with the included extraction tool, fitting the inner thread in the hole plate centre hole. The hygienic design provides easy access to and cleaning of all surfaces in contact with the product. The product area and drive components such as bearing etc. are completely separated by wide flushing channels with full visibility of and access to bearing sealings and drive clutches. This provides complete food safety as it is impossible for lubricants or bearing impurities to enter the product zone. Foldable safety fences prevent access to rotating parts during operation. All surfaces are either smoothly polished or ground and glass bead peened.



*Removal of breaker worm/auger for CombiGrind CG 225, CG 300, CG 300 Heavy Duty.*

## MIXERS FROM 200 L - 12,000 L



scansteel foodtech® Twin Shaft Mixer, TSM(V) positioning on rack extension.



scansteel foodtech® Twin Shaft Mixer, TSM(V) positioning on floor.



Inside view of scansteel foodtech® Twin Shaft Mixer, TSM(V)

### MIXERS: Side-by-side, TSM(V)

Twin Shaft Mixers

TSM - From 250 Litres – 12.000 Litres

Twin Shaft Mixers Vacuum

TSMV – From 250 Litres – 12.000 Litres

### MIXERS: Intermeshing TSMI(V)

Twin Shaft Mixers

TSM - From 200 Litres – 12.000 Litres

Twin Shaft Mixers Vacuum

TSMV – From 200 Litres – 12.000 Litres

### MIXERS: Single, SSM(V)

Single Shaft Mixers

SSM - From 250 Litres – 12.000 Litres

Single Shaft Mixers Vacuum

SSMV – From 250 Litres – 12.000 Litres

# Mixers

## MIXERS FROM 200 L - 12,000 L



scansteel foodtech® Twin Shaft Mixer, TSM(V) shown with back panel open, view of motors.



Close up view of load cells.



Close up view of operator panel with two hand JOG function for cleaning and inspection.



scansteel foodtech® Twin Shaft Mixer discharge gate system.

## OPTIONAL EXTRAS: MIXER WING TYPES



Paddle wings.



Spiral mixing wings.



Paddle mixing wings, special application.

## CO<sup>2</sup> / N<sub>2</sub> COOLING SYSTEM

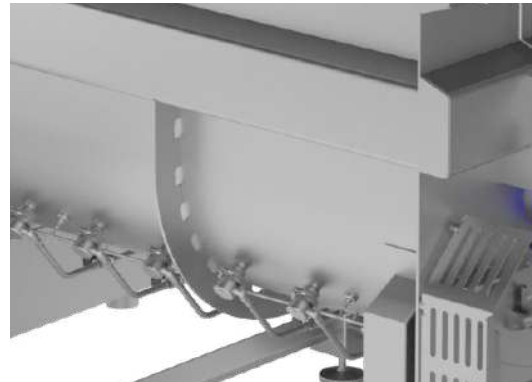
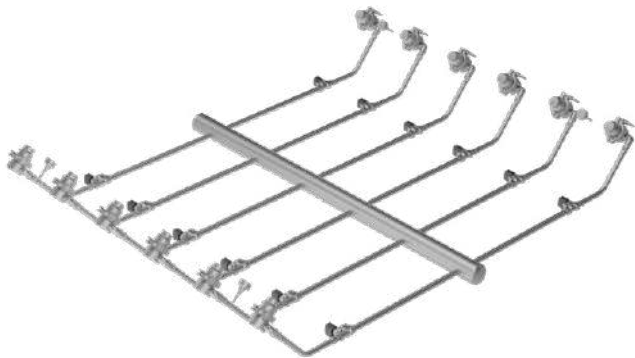

scansteel foodtech® Valves System and manifold. Each valve is equipped with a solenoid valve for individual control of each valve. (scansteel foodtech® CO<sup>2</sup> / N<sub>2</sub> Cooling System pictured to the right)

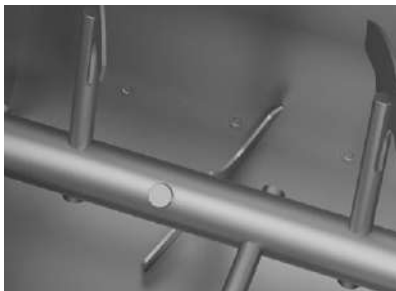

scansteel foodtech® Valves System seen from the inside of the mixer.



Valve shown mounted on mixer. Temperature sensor shown to the left and valve shown to the right.



Ultra hygienic valve mounting/dismounting design. Easy to clean and inspect.

## STEAM INJECT SYSTEM



Close up of scansteel foodtech® Bottom steam injection system shown on Twin Shaft Mixer, TSM(V)



Number of steam nozzles depending on mixer size.

## MIXERS: Side by side, TSM(V)

**Twin Shaft Mixers:**

TSM - From 250 litres - 6250 litres

**Twin Shaft Mixers Vacuum:**

TSMV - From 250 litres - 6250 litres

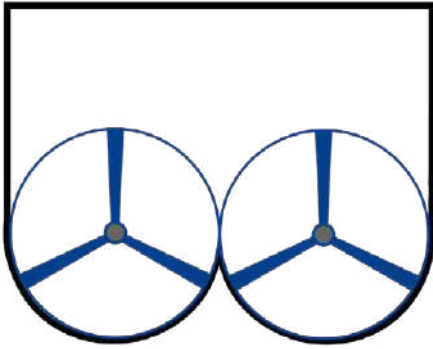

Left wing	Right wing	Wing rotation options for TSM(V) Series
		Left wing clockwise – Right wing clockwise
		Left wing counter clockwise – Right wing counter clockwise
		Left wing clockwise – Right wing counter clockwise
		Left wing counter clockwise – Right wing clockwise

## MIXERS: Intermeshing TSMI(V)

**Twin Shaft Mixers, Intermeshing:**

TSMI - From 200 litres - 12,000 litres

**Twin Shaft Mixers, Intermeshing Vacuum:**

TSMIV - From 200 litres - 12,000 litres

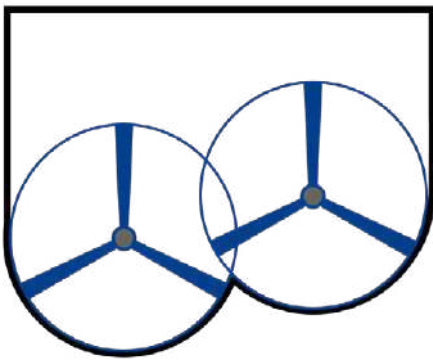

Left wing	Right wing	Wing rotation options for TSMI(V) Series
		Left wing clockwise – Right wing counter clockwise
		Left wing counter clockwise – Right wing clockwise

## MIXERS: Single, SSM(V)

**Single Shaft Mixers:**

SSM - From 250 litres - 12,000 litres

**Single Shaft Mixers Vacuum:**

SSMV - From 250 litres - 12,000 litres



Left wing	Wing rotation options for SSM(V) Series
	Left wing clockwise – Right wing clockwise
	Left wing counter clockwise – Right wing counter clockwise



## TWIN SHAFT MIXER GRINDER - TSMG SERIES

scansteel foodtech® Twin Shaft Mixer/  
Grinder – TSMG 1250/200



Electrical cabinets/operating panels, Allen Bradley or Siemens as standard.



Side panels for easy access to the interior of the machine.



Hygienic zones.

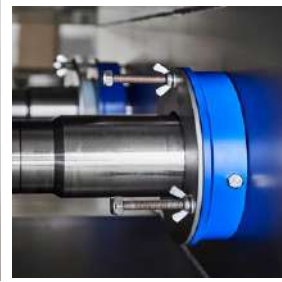

## Features and Optional Extras

---

### FEATURES:

- Constructed in stainless steel AISI 304.
- Safety equipment for CE conformity.
- Low energy consumption.
- Ideal for frozen meat and fresh/frozen mixtures. A flexible and high-performance mixing is given with both a high peripheral wing speed and a gentle handling of the mentioned raw materials.
- Minimum product residues and cross-mixing of batches, also including fully separated and sealed hygienic zone preventing any possible cross contamination.
- Various lid configurations: rear or side hinged. Optional as pneumatically operated.
- Computerized design of mixing wings and mixer geometry combined with the programmable mixing action ensures optimum processing results for you.
- Low noise level.
- Mixer controls available in range from ordinary push button operated versions to advanced PLC controlled systems. All PLC systems are supplied with reliable and easy accessible finger-touch operator panel with digital read-out of all mixer functions. Make Allen Bradley.

## Features and Optional Extras

---

### OPTIONAL EXTRAS:

- Dust lid without sealing
- Grill lid.
- Plate lid with sealing.
- Weighing system on frame.
- Weighing system, floor mounted.
- Frame prepared for weighing system.
- Temperature sensor (incl. in CO<sub>2</sub> and steam) – PT100.
- CO<sub>2</sub> top injection system with snow horns incl. control and lid.
- CO<sub>2</sub> bottom injection system.
- N<sub>2</sub> top injection system.
- N<sub>2</sub> bottom injection system.
- Steam bottom injection system incl. nozzles.
- Water dosing system, automatic.
- Double jacket for heating/cooling and insulation (not pressurized).
- Polished mixing container inside meat product zone.
- Interlock for trolleys - photo cell.
- Inspection platform, various executions.
- Mixing wings optional as standard paddle or spiral wings. Standard and paddle wings to run either side-by-side or intermeshing.

# Mixers

## TWIN SHAFT Z-ARM MIXER TSZM 2000



## SCANDEFROST SDV FROM 6000 L - 12,000 L - WITH VACUUM & BOTTOM DIRECT STEAM INJECTION

How to defreeze pre-ground or crushed frozen meat- and poultry blocks as well as frozen blocks of bones in minutes (NOT hours!) Frozen blocks directly from the freezer down to minus 30°C, before pre-grinding/crushing is not a problem with the scansteel foodtech® vacuum defrosting method and scanDefrost technology.



View of scansteel foodtech® scanDefrost nozzles / manifold system.



The scansteel foodtech® scanDefrost series has made production logistics much easier, as the meat raw materials to be further processed is taken directly from the freezer without time consuming storage in tempering rooms or other thawing facilities.

### The Method:

The scansteel foodtech® vacuum defrosting method provides defrosting of pre-crushed, frozen blocks of meat within minutes.

### Main advantages:

- NO drip loss
- The method is gentle to the meat and does not cause any denaturation.
- Does not cause any discoloration.
- All the valuable binding properties of the meat are maintained.

### The Benefits in General:

- Simple logistics and production planning due to processing directly from the freezer.
- Substantial savings in time, floor space, and energy.
- Better yield, no drip loss, no evaporation.



Frozen cow udder product before defreezing.

Cow udder product after defreezing.

Cow udder product discharged from the scanDefrost.

# Defrosting

## SCANDEFROST SDV FROM 6000 L - 12,000 L - WITH VACUUM & BOTTOM DIRECT STEAM INJECTION

### The Benefits with Specially Formed Products:

- Substantial energy- AND costs savings by avoiding defrosting completely.
- No need for CO<sub>2</sub> or LN<sub>2</sub> cooling gas (savings of up to euro 100 per ton of meat raw material produced).
- Up to 100% increase in mixing equipment efficiency.
- Up to 50% savings in space and electrical energy.

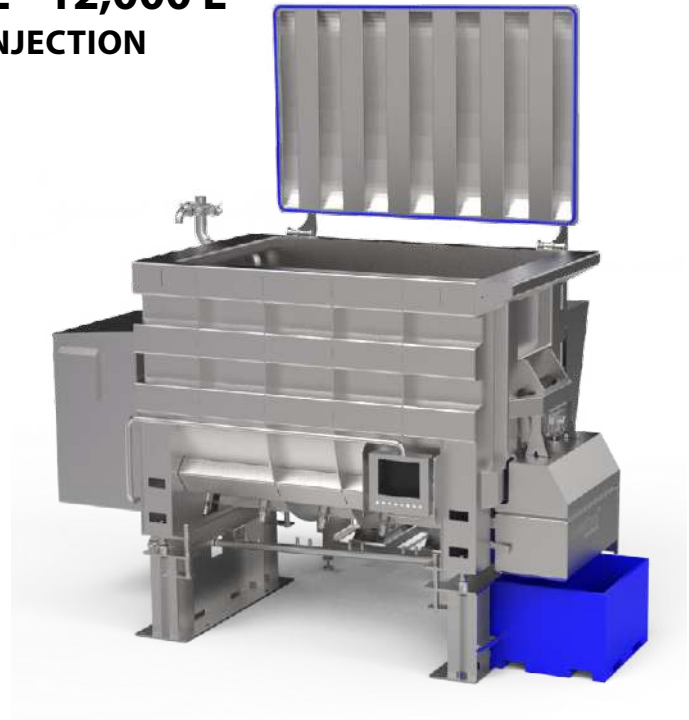

### DEFROSTING

Sizes

6000 L, 9000 L, 12,000 L

Motor sizes

37 - 55 kW



scanDefrost 6000 L.



scanDefrost 9000 L.

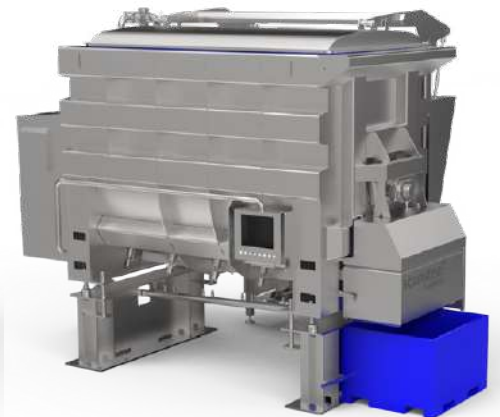

scanDefrost 12.000 L.

# Massagers/Tumblers

## SCANMESSAGE SMV FROM 2000 L - 12,000 L - WITH VACUUM

With optional scansteel foodtech® scanDefrost System, Temperature Monitoring/Control, and Insulation.



scansteel foodtech®  
scanMessage

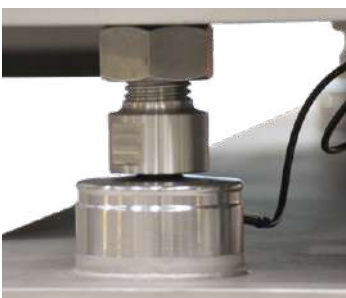

## SUPERPUMPS SP 200 / SP 250 / SP 290

The scansteel foodtech® SuperPump series comprises 3 (three) different pump sizes. Correct choice of pump depends on several factors such as, but not limited to, pump capacity, material to be pumped, temperature, viscosity, and particle size – from pre-ground meat raw material to half a pork carcass. One significant feature is the double discharge outlet which dramatically minimizes (eliminates) fluctuations in pump capacity. Pump motors are designed according to pump application.

### 1 Infeed Buffer/Hopper Solution

*Example of scansteel foodtech® SuperPump SP 2500 L silo/buffer hopper with stirring/feeding device with SuperPump SP 200.*



*2500 L silo/buffer hopper with stirring/feeding device. The stirring device feeds product to the centre for discharge into SuperPump SP 200.*



*The transmission of a SuperPump consists of individual planetary gear box and electric motor.*



*Pump transmission.*



## SUPERPUMPS SP 200 / SP 250 / SP 290

### 2 Infeed Buffer/Hopper Solution

Example of scansteel foodtech® SuperPump SP 290 with 300 liter infeed hopper with anti-bridging feeding device. Suited for pump applications where sparse footprint is available.



SuperPump SP 290 infeed hopper shown with rotating feeding device for feeding screw.

### 3 Infeed Buffer/Hopper Solution

SuperPump SP 290 with 3300 liter storage/buffer hopper.



## SUPERPUMP

Motor sizes

11 - 90 kW

## SUPERPUMPS SP 200 / SP 250 / SP 290

### 4 Infeed Hopper Solution

*SuperPump SP 250 with 250 liter hopper.*



*Superpump SP 250 shown below feeding a scanDebone 150.*



## SUPERPUMPS SP 200 / SP 250 / SP 290

SuperPump solution being fed directly by frozen block grinder.  
Example: blocks ground through frozen block grinder, through final hole plate from Ø6 mm to Ø30 mm according to customer request.



SuperPump SP 290 showing double pump discharge.



Side view of SuperPump SP 290.



Pump housing.

### PUMP HEAD ASSEMBLY:

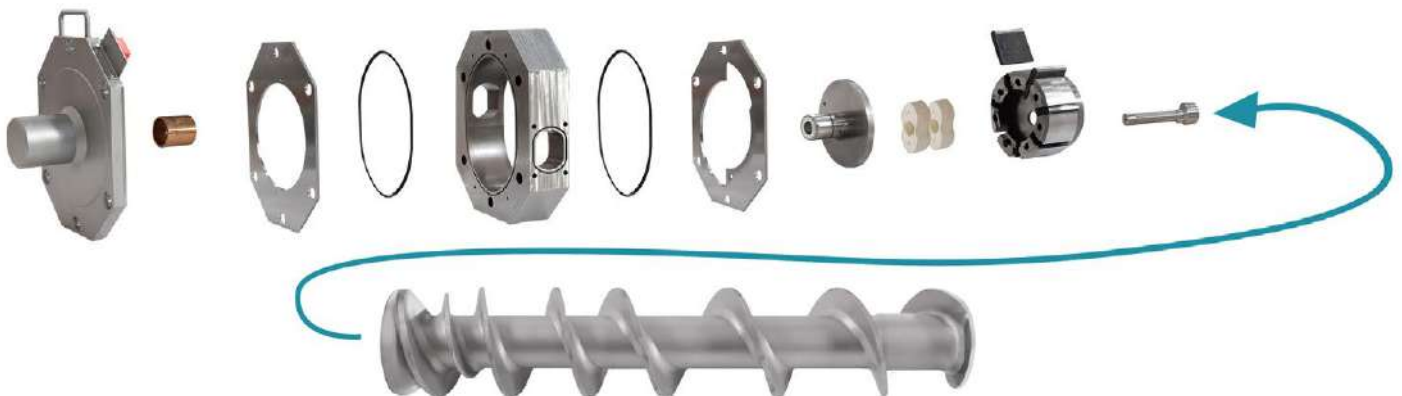

## CONTIPUMP FROM 500 L – 10,000 L BUFFER HOPPER

The scansteel foodtech® ContiPump series is for less Heavy Duty applications such as, but not limited to, pre-mixes being fed into an emulsifier as well as for various buffer/storage/silo applications. The buffer hopper comes in 2 (two) versions: one single feeding screw or twin (two) feeding screws, where one screw feeds/drives the ContiPump while the other prevents/limits bridge building.



ContiPump 4000/250 Twin Screw  
Shown fully assembled ready for  
production. Shown with all safety  
rails in position.

ContiPump 4000/250 Twin  
Screw. The operator panel is  
shown together with a level  
control.

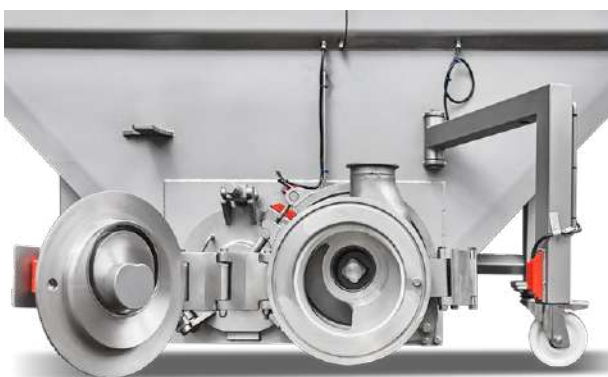

ContiPump pump housing, hinged.



Shown above: Close-up of pump housing and side panel for  
second screw. Both designed for easy assembly/disassembly.

## CONTIPUMP FROM 500 L – 10,000 L BUFFER HOPPER



Accessory/cleaning trolley for ContiPump.



Inside view of ContiPump 4000/250 Twin Screw. Can also be supplied with top stirring device.



The scansteel foodtech® ContiPump series has been designed in such a way that the unit can function as a stand alone pump or, as shown above, can be designed to fully be integrated as part of an integrated solution with the scansteel foodtech® ContiPump and the scansteel foodtech® mixer series. In order to secure full hygiene solutions as well as having full access to both the mixer(s) and ContiPump for inspection/maintenance. The scansteel foodtech® ContiPumps can be placed on a "rail system" which makes it fully possible for a person to separate the ContiPump and mixer. At the same time, during production, the ContiPump is secure in "running position" in such a way that the ContiPump cannot be moved.

### CONTIPUMP:

Standard hopper sizes	250 - 4250 L
Gear motor for pump section	4- 11- kW
Gear motor for screw section	5,5 - 7,5 kW

## CONTIPUMP FROM 500 L – 10,000 L BUFFER HOPPER

scansteel foodtech® ContiPump series comes in many different infeed hopper designs. Below shows a ContiPump being fed by a scansteel foodtech Mixer/Grinder.



Top view of the scansteel foodtech® ContiPump and Mixer/grinder.

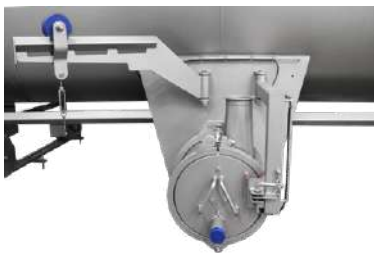

# Emulsifiers - Overview

## SCANEMUL 175

scanEmul 175 hopper fed



scanEmul 175 screw hopper fed



scanEmul 175 pump fed



## QUADROCUT 225 / QUADROCUTVAC 225

Quadrocult 225



QuadrocultVac 225



QuadrocultVac 225 - TemBi



## MC 250 & MC 300

MicroCutter MC 250 - Pump fed



MicroCutter MC 250 - Hopper fed



MicroCutter MC 250 - Screw hopper fed

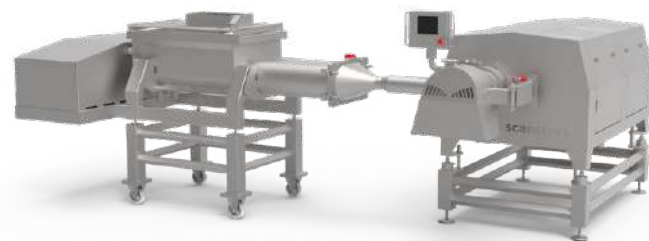

## PRE-EMULSIFIERS

PE 400



PE 500



# Emulsifiers – scanEmul 175

## SCANEMUL 175 - HOPPER FED

The scansteel foodtech® scanEmul 175 - Hopper fed emulsifier combines efficient and simple operation with high continuous performance, long durability, and low running and maintenance costs. The scanEmul 175 knife cassette system ensures the same uniform final particle size/emulsion quality for every production run, improve the level of fineness, optimize the protein extraction and increase production capacity. It therefore meets all the requirements for quality-oriented uniform production



*Emulsion from the scanEmul 175 - hopper fed.*

## Ultra-Flexible Knife System Set-up

The scansteel foodtech® scanEmul 175 - Hopper fed knife cassette system has been designed so it can be assembled at the workshop by trained technicians. As such, the only thing the machine operators must do is to replace the knife cassette at agreed intervals.



*Knife cassette of scanEmul 175 - Hopper fed shown assembled.*



*Assembly of the scanEmul 175 - Hopper fed knife cassette system. Quick and easy handling.*

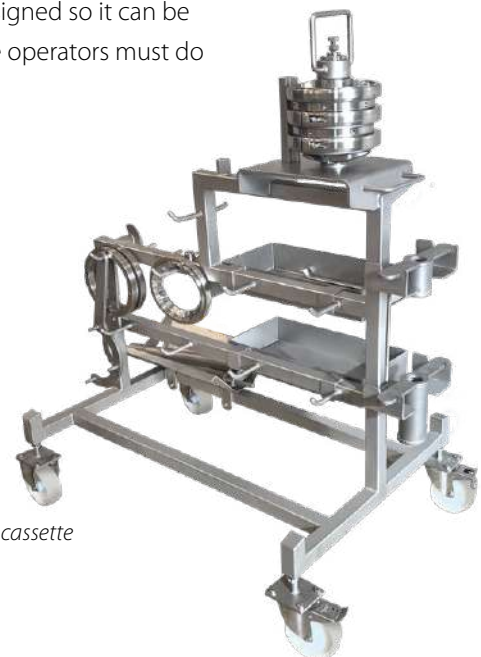



# Emulsifiers – scanEmul 175

## SCANEMUL 175 - SCREW HOPPER FED



*Above picture shows triple knife set, loose parts when scanEmul 175 is disassembled, together with tooling for assembly/disassembly.*



# Emulsifiers – scanEmul 175

## SCANEMUL 175 - PUMP FED

*On picture (to the right hand side), the scanEmul 175 is shown positioned on a sub-frame to ensure good access for mounting/ dismantling of knife sets as well as for easy access at periodical maintenance.*

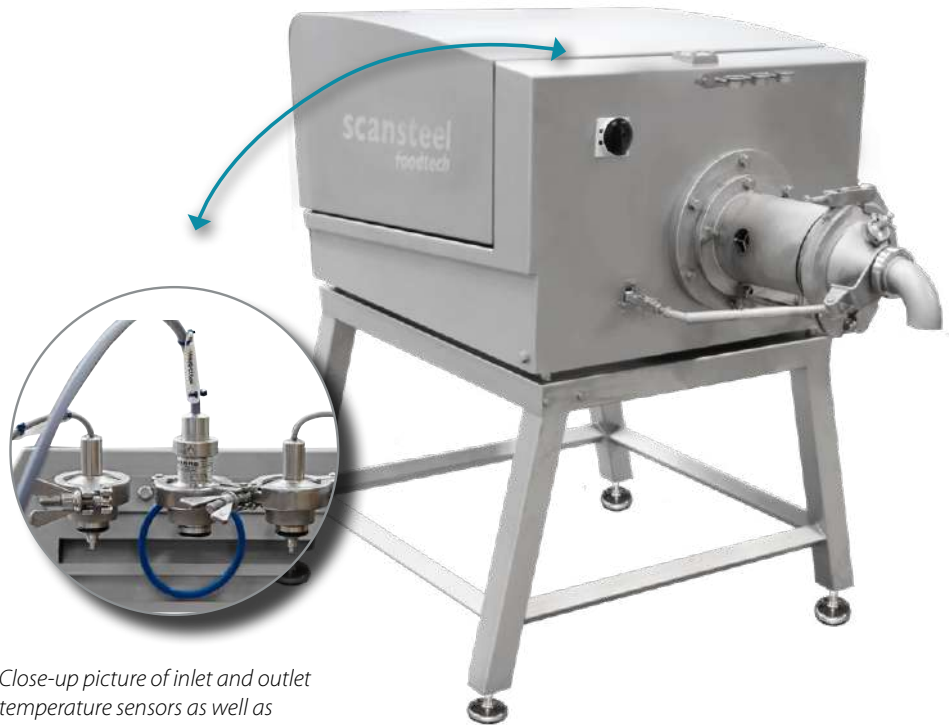

*Close-up picture of inlet and outlet temperature sensors as well as pressure transducers.*

*The scanEmul 175 shown below with a scansteel foodtech® ContiPump 250 with Twin Screw to avoid bridge building. Typically, the ContiPump 250 is positioned so either one or two mixers can discharge into the infeed hopper of the ContiPump 250.*

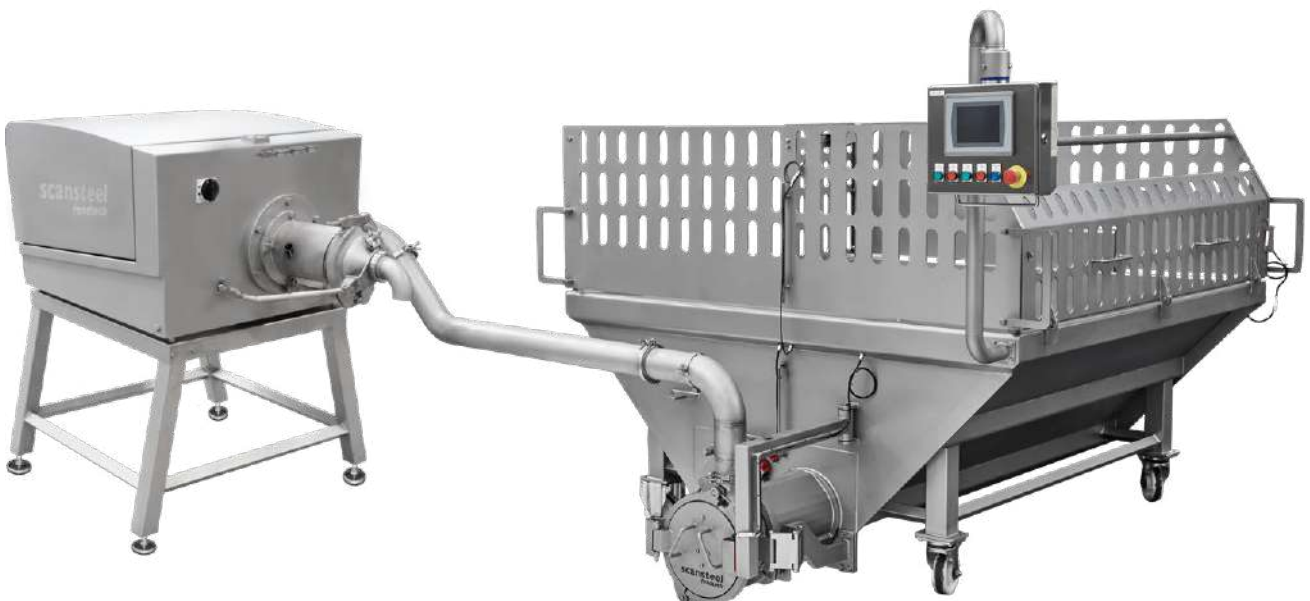

# Emulsifiers – QuadroCut 225

## QUADROCUT 225

The scansteel foodtech® QuadroCut 225 emulsifier is the Heavy Duty “Work Horse” among emulsifiers. The scansteel foodtech® QuadroCut 225 is designed for Heavy Duty applications with heavy duty construction from the ground up. The robust frame is designed to easily withstand the forces from electrical motors from 90 kW – 200 kW. All frame and cabinet work is manufactured in stainless steel AISI 304.



QuadroCut 225.

Side view of the QuadroCut 225 without panels.

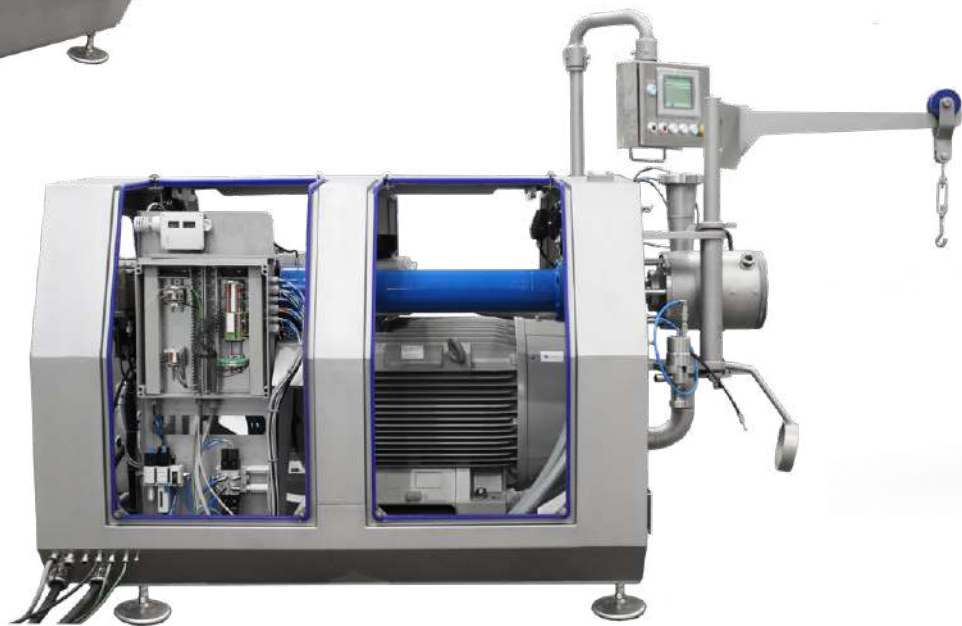

Inside view of QuadroCut 225 output shaft from the left angle.



Inside view of QuadroCut 225 output shaft from the right angle.

# Emulsifiers – QuadroCut(Vac) 225 **scansteel®** foodtech

## QUADROCUT VAC 225

The scansteel foodtech® QuadroCutVac 225 is the ultimate solution for production of high quality emulsion, fully inline and continuous vacuumizing for removal of air in the final emulsion. Shown with 2500 liter infeed buffer hopper. The QuadroCutVac 225 is further shown with open lid showcasing the easy cleaning and inspection access for the vacuum section of the QuadroCutVac 225.

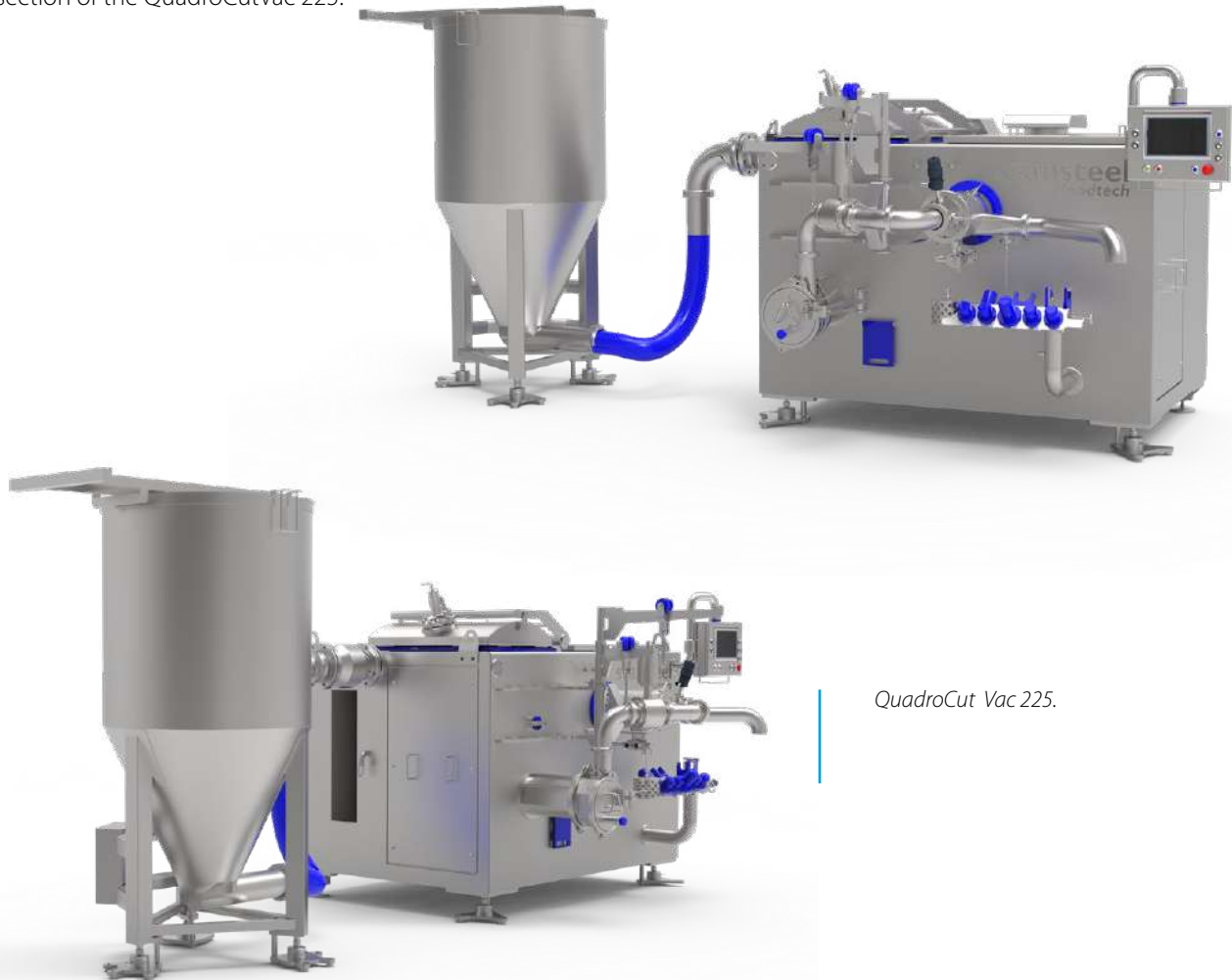

*QuadroCut Vac 225.*

## Ultra-Flexible Knife System Set-up

The scansteel foodtech® knife set cassettes have been designed so they can be assembled at the meat processors' workshop by trained technicians. As such, the only thing the machine operators must do is to replace the knife cassette at agreed intervals.

Example: many manufacturers require the final meat and bone product to have a maximum particle size of 1.0 mm or less. This can be achieved with the PentaCut 225 knife set-up.

### Knife Set Combinations:

- QuadroCut 225: 4 knives – 3 hole plates
- TripleCut 225: 3 knives – 2 hole plates
- DoubleCut 225: 2 knives – 1 hole plate



# Emulsifiers – QuadroCut(Vac) 225 - TemBi

## QUADROCUTVAC 225 - TEMBI



QuadroCutVac 225 - Tembi

### Technical Specifications for QuadroCut(Vac) 225 Series

Motor size:	Standard range: 90 kW – 200 kW.
Emulsion production capacity:	4000 – 20,000 kg/hour.
Electrical controls:	Allen Bradley operator panel and PLC. Siemens operator panel and PLC.
Emulsifier knife set speed:	Frequency controlled speed of 2200 – 3000 rpm. Typically, the most important speed control is given by the infeed pump speed which can be pre-programmed in the control panel of the emulsifiers.
Main bearing:	Oil filled bearing. Oil cooled.

# Emulsifiers – QuadroCut(Vac) 225 scansteel® foodtech

## EMULSIFIERS, QUADROCUT 225 & QUADROCUTVAC 225 - KNIFE CASSETTE ASSEMBLY

1



2



3



4

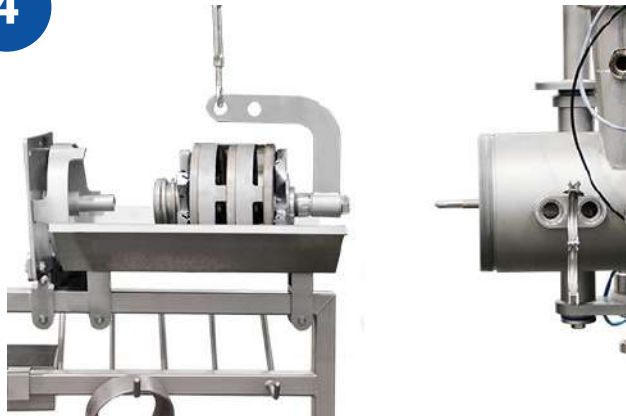

5



6



# Meat-Bone Separators

## SCANDEBONE 100 & SCANDEBONE 150

### - PUMP FEED SYSTEM

scansteel foodtech® scanDebone 100 & scanDebone 150 are high-quality mechanical deboning machines for meat-bone separation for the poultry and processing industries. scanDebone 100 & scanDebone 150 are designed in such a way that the final product temperature increase has been minimized throughout the entire operation.

The scansteel foodtech® scanDebone series produces an adjustable, very high yield and at the same time it produces a final product with low calcium content in the final poultry and fish raw materials, which supports a high product quality.



Superpump SP 250 shown below feeding a scanDebone 150.



scanDebone 150 shown without slit filter.



scanDebone mounted with slit filters.



Slit filter seen from inside.



Final product: deboned poultry. View 1 (one).

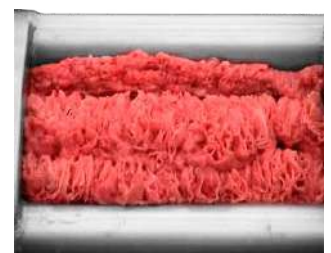

Final product: deboned poultry. View 2 (two).

# Gravy Production Systems

## SCANGRAVY

The scansteel foodtech® scanGravy mixing and storage series has been designed to manufacture a wide range of gravies, from light weight gravies to heavy viscous gravies. The scanGravy mixing and storage units are manufactured from 500 L – 6000 L. One entire system is controlled and operated by its own dedicated PLC system with optional software.



Right hand side: scansteel foodtech® mixing unit with high speed dry ingredients addition Venturi system.  
Left hand side: scansteel foodtech® storage unit.



Mixing container designed for heavy viscous gravies/mixtures. The Ytron and the Venturi system in combination with the Heavy Duty mixing agitators ensure a fast processing of a gravy free from lumps. Anti-vortex breakers are standard in all scanGravy mixing tanks. Direct steam injection for temperature control can be added as well.



Pumps are positioned/mounted on their own frame for easy access at inspection/maintenance, etc. In addition, the pump of the scanGravy mixing unit can be equipped with its own knife system for eliminating lumps in "challenging to produce" gravies.



# Gravy Production Systems

## scansteel foodtech® scanGravy with Ytron Powder Dispenser - Heavy Duty Applications



The mixing tank is used to dissolve or disperse powdered products in a liquid or to mix different liquids, with the Ytron powder dispenser for dissolving all dry "challenging to add" matters/ingredients in the gravy and/or the brine.

The Ytron in combination with the scanGravy secures complete dissolving of all dry matters, each particle is enclosed by water, ensuring that no "clumps" will occur. At the same time, use of ingredients can be minimized.

The liquid is circulated by a centrifugal pump, after which the hopper is loaded with ingredients such as salt, phosphate, soy protein, starch, and/or spices.

When the Gravy solution is fully dispersed, it can be pumped directly to a scanGravy storage tank. Dry matter inlet hopper: Approx. 15 l.

## scansteel foodtech® scanGravy with Venturi System



scansteel foodtech® high speed dry ingredients addition Venturi system. For addition of all kinds of dry ingredients. Prevents air injection into gravy during production of same.

## SILO SYSTEMS

Over the years, scansteel foodtech A/S has gained substantial experience within both manual batching (swing loaders) and weighing equipment as well as automated batching and weighing (silo) systems.

### Silo Systems:

Each silo typically from 2000 - 10,000 litres. Each silo is capable of storing pre-ground, frozen meat raw material as well as fresh meat raw material. Each silo is typically equipped with a stirring device/wing to prevent pre-ground meat raw material from freezing together, and is typically equipped with weighing-/load cells to accurately control the batch weight just as the weighing-/load cells are used to accurately weigh out the exact amount(s) according to the recipes. The scansteel foodtech® silos are typically equipped with a discharge screw which handles both pre-ground, frozen- and fresh meat raw materials.



# Storage & Batching Systems

## FULLY AUTOMATIC SILO SYSTEMS

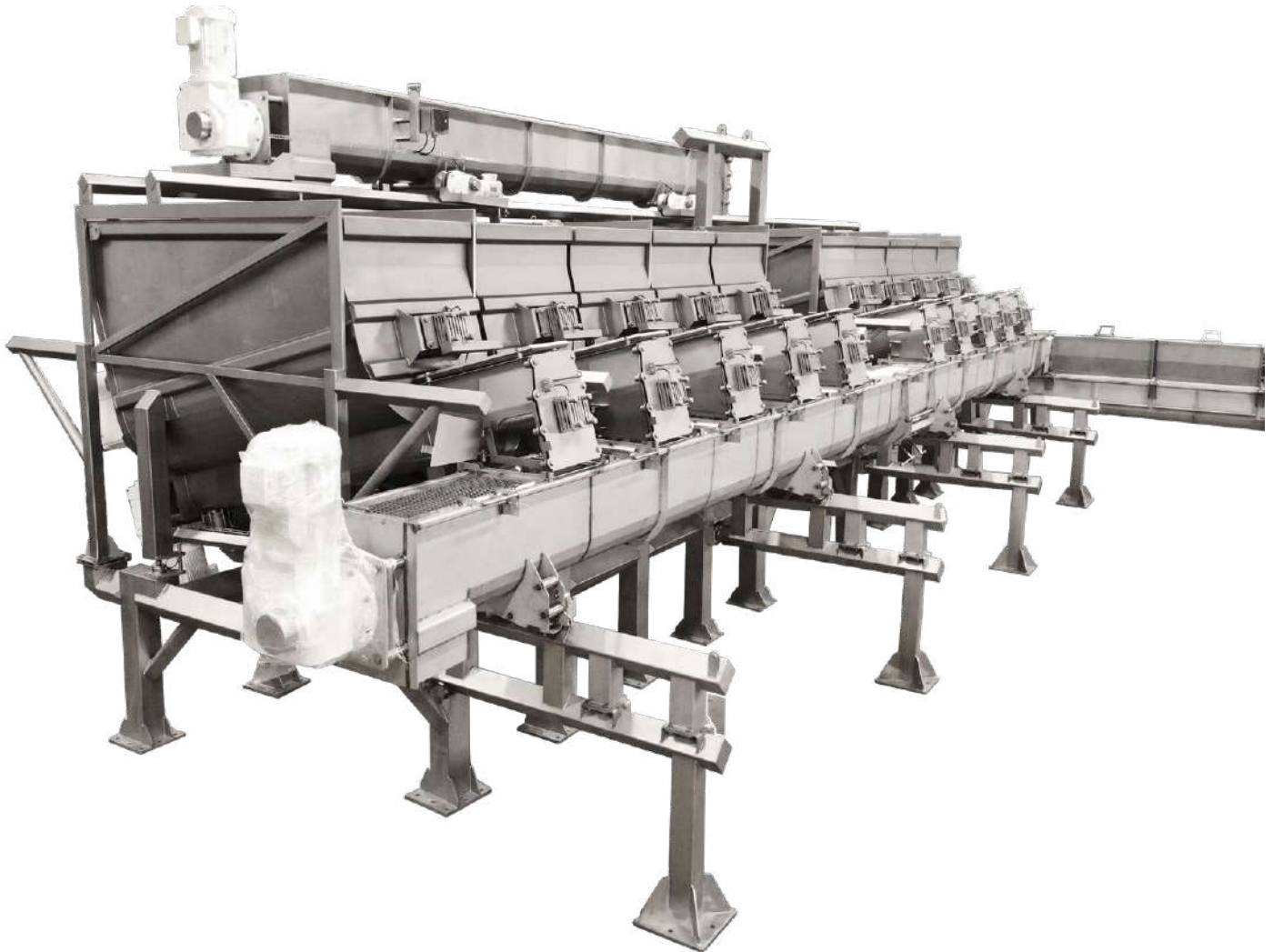

scansteel foodtech 10 unit silo system with 3000 liter silos. Showing both horizontal infeed screw for feeding the silos as well as discharge screw showing how the batching and discharge of the silo system. Typically, each scansteel foodtech silo is equipped with load-/weighing cells and as such the silos can discharge simultaneously in order to create recipes fastest possible, and without delay. It is also shown that the large discharge- and batching screw can easily be pulled out for inspection and maintenance.

View of the silo discharge screw of the silos showcasing the easy access for cleaning and inspection without hidden surfaces.



# Storage & Batching Systems

## SWING LOADER WITH WEIGHING BELT

This is a line consisting of typically 3-10 swing loaders which require 1 (one) person (operator) only. One person (operator) can semi-automatically/semi-automatically weigh out between 2-6 batches per hour and as such, the same person (operator) can quite easily feed a continuous processing line with two or more mixers.



6 (six) unit weighing station, seen from the infed side. Typically, Dolav bins are fed into the swing loaders by a fork lift truck. All is controllable from the operator panel.



6 (six) unit weighing station, seen from the batching/weighing side. The operator looks at the control panel to the right to check how many kilos he requires of a certain meat raw material. Next, the operator looks at the operator panels in front of each swing loader to see where he has to unload/weigh out the volume of the meat required. The weighing belt is equipped with 4 (four) load cells in order to monitor weights continuously.

# Storage & Batching Systems

## SWING LOADER WITH WEIGHT INDICATOR



Overview of the entire weighing and batching station, seen from the batching/weighing side.



Control panel for operator instructions in terms of next meat raw material to weigh out.



Details showing drip trays and weighing/load cells.



Line control of weighing and batching station.

# Storage & Batching Systems

scansteel foodtech A/S has a wide range of different standard solutions for both weighing and batching applications. In addition, we do design and manufacture tailor-made systems according to customers' requirements and demands.



Belt conveyors with a range of standardized side rails and drip pans to avoid moisture and liquids on the floor.



All scansteel foodtech® belt conveyors can be equipped with weighing cells/ system for exact batching.



One option in the scansteel foodtech® "batching family of solutions" is a station of typically 2 – 8 swing loaders (tippers) which can hold different meat raw material.



With the scansteel foodtech® line control, it is possible to guide the operator into the exact amount of each meat raw material to be unloaded onto the weighing/batching belt conveyor.

## INFEED SYSTEMS FOR GRINDERS - FROZEN BLOCKS - BELT CONVEYORS

scansteel foodtech A/S manufactures a wide range of belt conveyors. Except for a range of standard belt conveyors, scansteel foodtech A/S designs belt conveyors according to customer requests and requirements. All frames are manufactured in stainless steel, and belt types can vary to customer request and requirements. The scansteel foodtech® belt conveyors are driven by either drum motors or gear box motors, again according to customer requirements. In addition, belt conveyors can be equipped with metal detectors and/or blue plastic detectors.



*Example of scansteel foodtech® infeed systems shown with belt conveyor, unpacking station and CombiGrind CG 300 HD*



*Belt Conveyor with unpacking station with 2 (two) lifting tables for ergonomics, left side.*



*Belt Conveyor with Unpacking station with 2 (two) lifting tables for ergonomics, right side.*

## INFEED SYSTEMS FOR GRINDERS - FROZEN BLOCKS - BELT CONVEYORS

*Standard scansteel foodtech® inclined belt conveyor with metal detector for feeding a grinder. Shown with unpacking table with weighing/load cells for batching purposes.*



*Standard scansteel foodtech® inclined belt conveyor with metal detector, side view. scansteel foodtech A/S can deliver our belt conveyors with any brand type metal detector. Side view.*



*Standard scansteel foodtech® inclined belt conveyor with metal detector, Front top view. scansteel foodtech A/S can deliver our belt conveyors with any brand type metal detector. Front top view.*



# Product Transfer Equipment

## INFEED SYSTEMS FOR GRINDERS - FRESH MEAT RAW MATERIAL - BELT CONVEYORS

Example of a scansteel foodtech® solution feeding fresh meat raw materials into a grinder with continuous metal detection. Fresh meat raw material is fed onto the belt conveyor via a scansteel foodtech scanSwing loader. This solution can also be supplied with a combined solution of both fresh- and frozen meat raw materials.



Top view of scanSwing loader and belt conveyor

## INFEED SYSTEMS FOR GRINDERS - BELT CONVEYORS

*scansteel foodtech® inclined belt conveyor with metal detector, for feeding of frozen blocks, and automatic reject of frozen blocks being detected with metal pieces.*



*scansteel foodtech® inclined belt conveyor with metal detector.*



*Inclined belt conveyor with side racks.*

## DISCHARGE SOLUTION FOR GRINDERS - HORIZONTAL BELT CONVEYORS



Another typical horizontal belt conveyor solution where 2 (two) grinders are discharging onto the scansteel foodtech® belt conveyor. This solution saves a lot of safety devices and, at the same time, secures easy access to the grinders for cleaning, mounting, and dismantling of the grinders, front view.

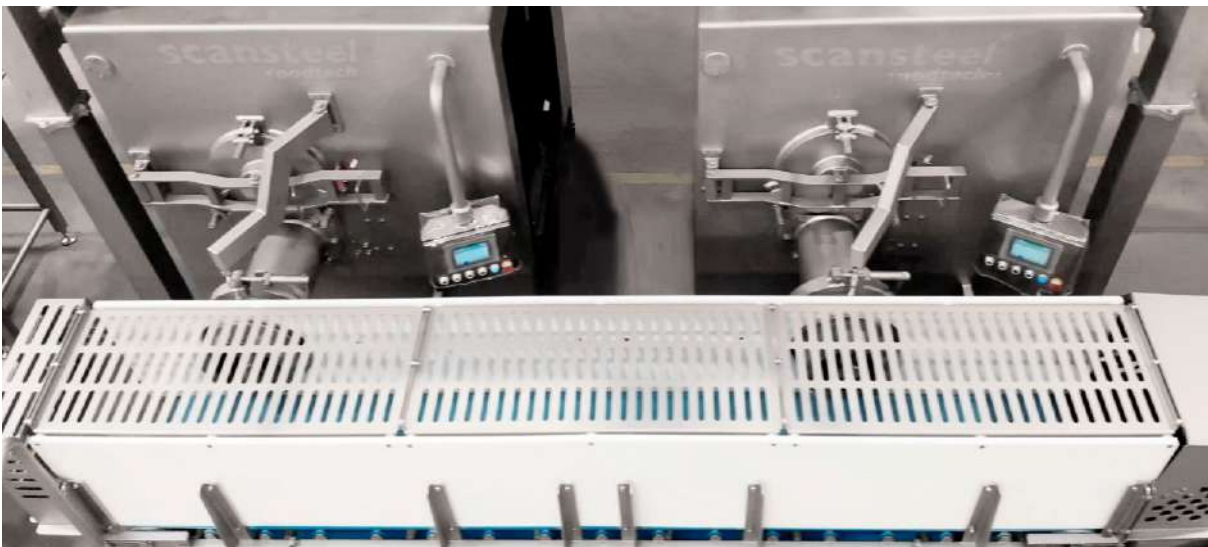

Another typical horizontal belt conveyor solution where two grinders are discharging onto the scansteel foodtech® belt conveyor. This solution saves a lot of safety devices and, at the same time, secures easy access to the grinders for cleaning, mounting and dismantling of the grinders, top view where the transfer point from grinders to belt conveyor is clearly seen.



All scansteel foodtech® belt conveyors can upon customers request be manufactured with drip trays/ collection pans in order to avoid moisture on the floor.

# Product Transfer Equipment

## DISCHARGE SOLUTION FOR GRINDERS / FEEDING OF MIXERS -SCREW CONVEYOR & BELT CONVEYOR SOLUTIONS

scansteel foodtech A/S supplies various solutions where screw- and belt conveyors are combined. A typical solution might be discharging from one or two grinders into two or more mixers.



Close-up view showing scansteel foodtech® inclined screw conveyor feeding onto a scansteel foodtech® horizontal belt conveyor which has 3 (three) main positions.

This position shows the belt conveyor feeding a scansteel foodtech® mixer on left hand side.

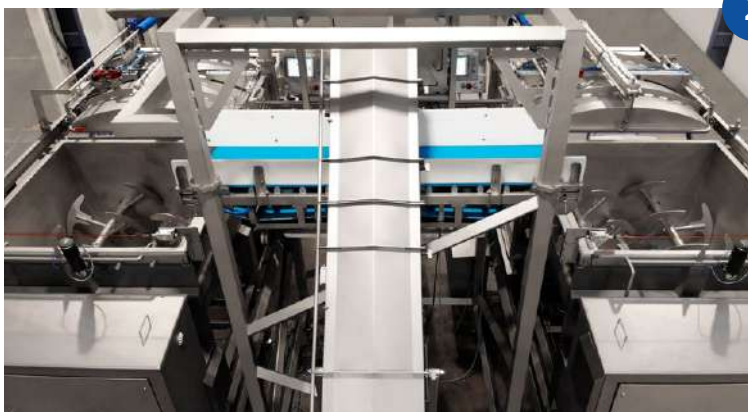

Close-up view showing scansteel foodtech® inclined screw conveyor feeding onto a scansteel foodtech® horizontal belt conveyor which has 3 (three) main positions.

This position shows the belt conveyor in neutral position in order for both mixer lids to be capable of closing.

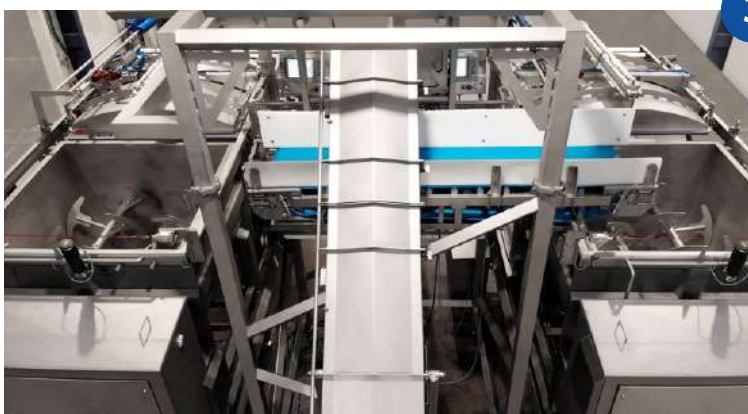

Close-up view showing scansteel foodtech® inclined screw conveyor feeding onto a scansteel foodtech® horizontal belt conveyor which has 3 (three) main positions.

This position shows the belt conveyor feeding a scansteel foodtech® mixer on right hand side.

# Product Transfer Equipment

## SCREW CONVEYORS Ø240 - Ø600 MM - INCLINED, HORIZONTAL, AND VERTICAL SCREW CONVEYORS

From 1500 - 10,000 mm in length. scansteel foodtech A/S has a full range of standard designed screw conveyors. In addition, 100% tailor-made screw conveyors, designed according to customer request, are also available. As optional extras, the scansteel foodtech® range of screw conveyors can be supplied with or without hydraulic lifting and lowering systems.



Example of infeed section for grinder.



Heavy Duty shaft bearings shown.



Standard screw conveyor electrical/operator panel.



Please also note built-in drain plug for draining/cleaning purposes.

# Product Transfer Equipment

## SCREW CONVEYORS Ø240 - Ø600 MM

- INCLINED, HORIZONTAL, AND VERTICAL SCREW CONVEYORS



*Inclined screw conveyor with hydraulic knockdown system for cleaning, inspection, and maintenance purposes.*



*Screw conveyor in knock down position ready for inspection and/or cleaning.*

## SCANGIRAFF WITH SILO/BUFFER

*Example of scansteel foodtech® scanGiraff with buffer silo with stirring/feeding device to prevent bridge building.*



*scansteel foodtech® standard scanGiraff, showing vertical screw.*

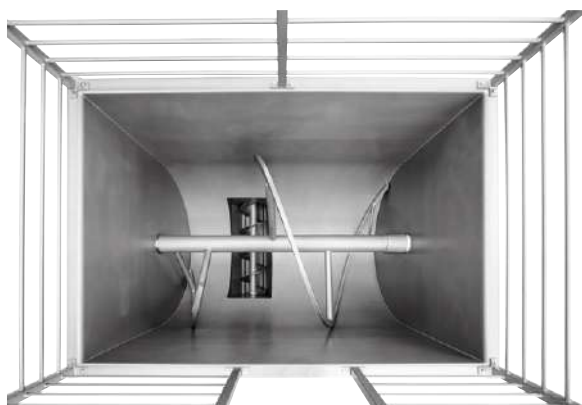

*Top view of scansteel foodtech® standard scanGiraff, showing stirring/feeding device.*

# Product Transfer Equipment

## SCANGIRAFF Ø240 MM



*scansteel foodtech® standard scanGiraff for positioning under a grinder and/or a flaker.*



*scansteel foodtech® standard scanGiraff shown in cleaning position. Note the vertical screw is 100% accessible for cleaning (no hidden zones).*



*Large diameter infeed screw in horizontal infeed hopper.*



# Product Transfer Equipment

## SCANGIRAFF Ø470 MM FOR HEAVY DUTY APPLICATIONS



*scanGiraff shown in closed position, ready for production.*



*scanGiraff shown in cleaning and inspection position.*



*Infeed hopper shown with safety guard/grill in running position.*



*Infeed hopper shown with safety guard/grill in cleaning and inspection position.*

## SCANLIFT SINGLE COLUMN

- FULL RANGE OF STANDARD LIFTING DEVICES FOR 200 - 300 L TROLLEYS



scanLift SC 350  
shown with 220 L trolley.

scanLift SC 350  
shown with 300 L trolley.



scanLift SC 350 with 220 L trolley shown in  
discharge position. Equipped with discharge  
chute/non-spill chute.



scanLift SC 350 electrical/operator panel.

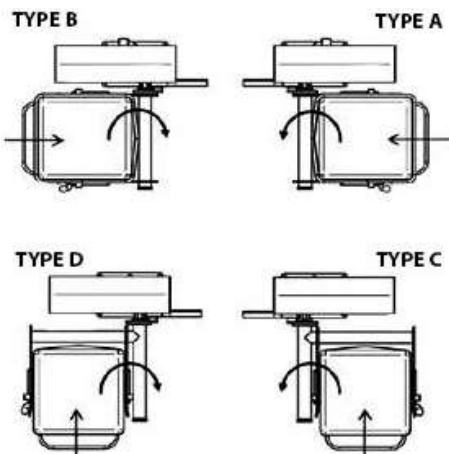

Type A and B Discharge Height in mm.	Type C and D Discharge Height in mm.
1400 – 1700	1400 – 1700
1700 – 2000	1700 – 2000
2000 – 2300	2000 – 2300
2300 – 2600	2300 – 2600
2600 – 2900	2600 – 2900
2900 – 3200	2900 – 3200
3200 – 3500	3200 – 3500
3500 – 3800	3500 – 3800
3800 – 4100	3800 – 4100

## SCANLIFT SINGLE COLUMN

- FULL RANGE OF STANDARD LIFTING DEVICES FOR 200 - 300 L TROLLEYS



Special application  
kettle/bowl.

### **i** Please contact us

Please contact scansteel foodtech  
A/S for special application/lifting  
devices for boxes, trolleys, and Dolav  
boxes.

scanLift SC 350  
shown with safety cage.



# Product Transfer Equipment

## SCANLIFT DOUBLE COLUMN

- ALL TYPES OF 220 - 300 L TROLLEYS AND BOXES/DOLAV BOXES

Double column lifting device  
for plastic/metal crates/boxes.  
– Dual function, shown with  
plastic crates/boxes.



Double column lifting device  
for plastic/metal crates/boxes.  
– Dual function, shown with  
200/300 L trolley.



Detail showing how forks  
for 200/300 L trolley work  
combined with plastic/metal  
crates and boxes.

## SCANLIFT DOUBLE COLUMN LOADER WITH PALLET INVERTER

This is the ultimate Heavy Duty Double Column Loader with built in hydraulic pallet inverter, scanLift has been designed for lifting/feeding of whole pallets of frozen blocks, containers of frozen blocks and similar applications. A typical application is feeding into the scansteel foodtech® whole Pallet Crusher, WPC series. The built in pallet inverter eliminates the need for a stand alone pallet inverter (depending on exact and specific application and customer needs/demand).



*The scanLift Double Column loader with pallet inverter shown with all safety fences is running position.*

*The scanLift Double Column loader with pallet inverter shown in infeed position with safety gate open. Also the pallet inverter is shown. Typically the double column loader is loaded with a fork lift truck.*



# Pallet Inverter

## PALLET INVERTER PI 1500

The scansteel foodtech® Pallet Inverter PI 1500 is designed to work in food environments under wet conditions. Complete stainless-steel execution (except from hydraulic unit).



scansteel foodtech® Pallet inverter PI 1500 shown in start / loading position.



scansteel foodtech® Pallet inverter PI 1500 shown in horizontal running position.

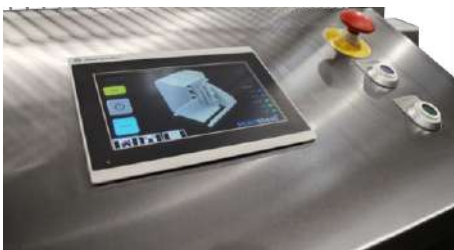

Electrical panel, including touch panel and manual buttons. The cabinet is certified stainless steel, AISI 304 execution.



View inside electrical panel.



Pallet inverter seen from behind without cover, view of hydraulic unit and turning device.



# Product Transfer Equipment

## SCANSWING LOADER

- scansteel foodtech A/S HAS A FULL RANGE OF SWING LOADERS

scansteel foodtech®  
scanSwing  
loader in down  
position.



scanSwing loader  
in empty position.



Machine feet which can be mounted  
to the floor.



Operator/control panel with emergency  
stop.

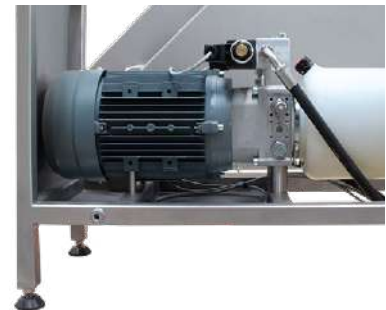

Inside view of hydraulic system.

# Line Control System

## scansteel foodtech® LINE CONTROL SYSTEMS

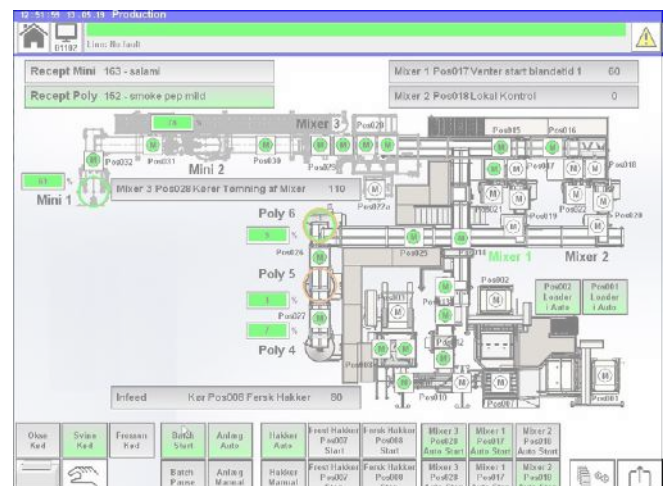
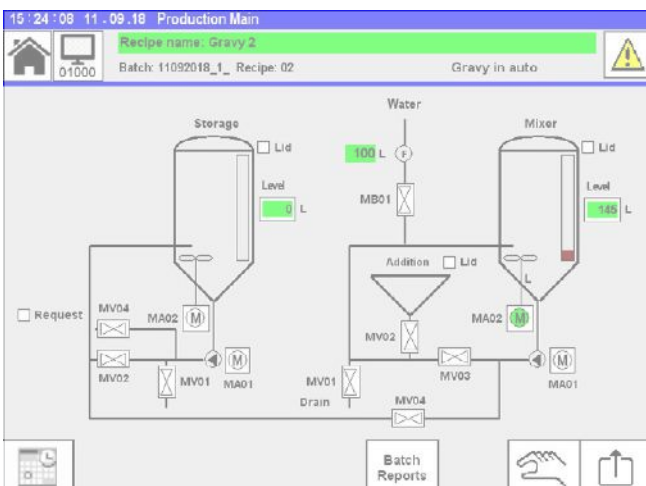
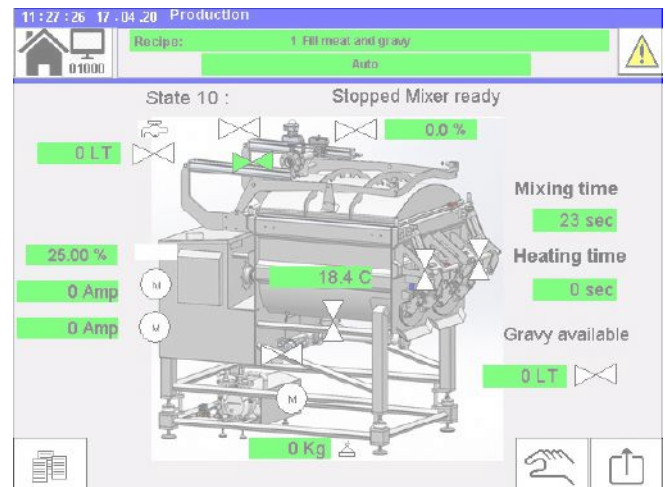
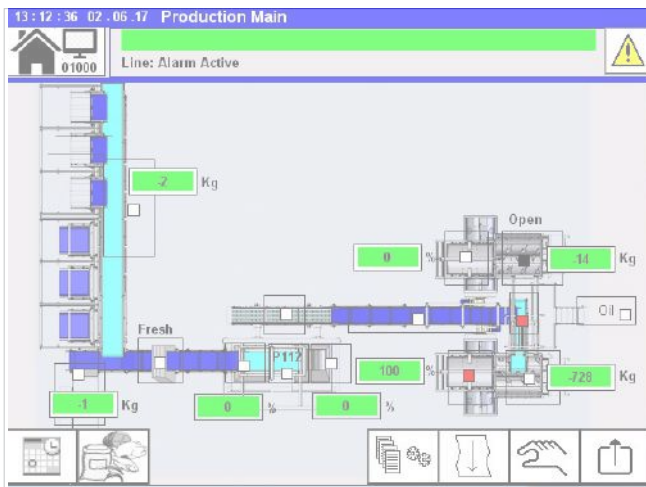

## REMOTE ONLINE SUPPORT SYSTEM

**EWON Module** - To allow remote automation assistance from scansteel foodtech A/S.

When a scansteel foodtech® line is optionally equipped with a EWON module it is possible for scansteel foodtech A/S to go into the PLC via internet connection by an EWON Module. This makes it possible to offer the best and quickest service.





## STANDARD LINE 1

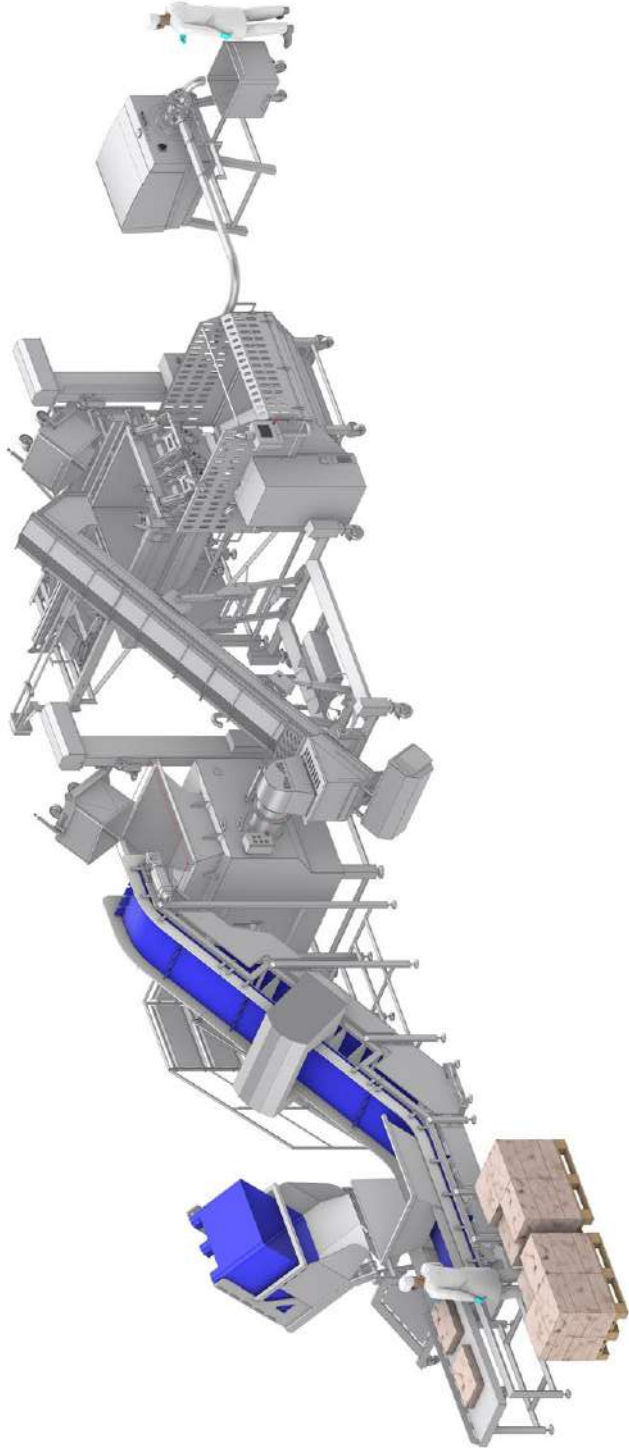

## STANDARD LINE 2

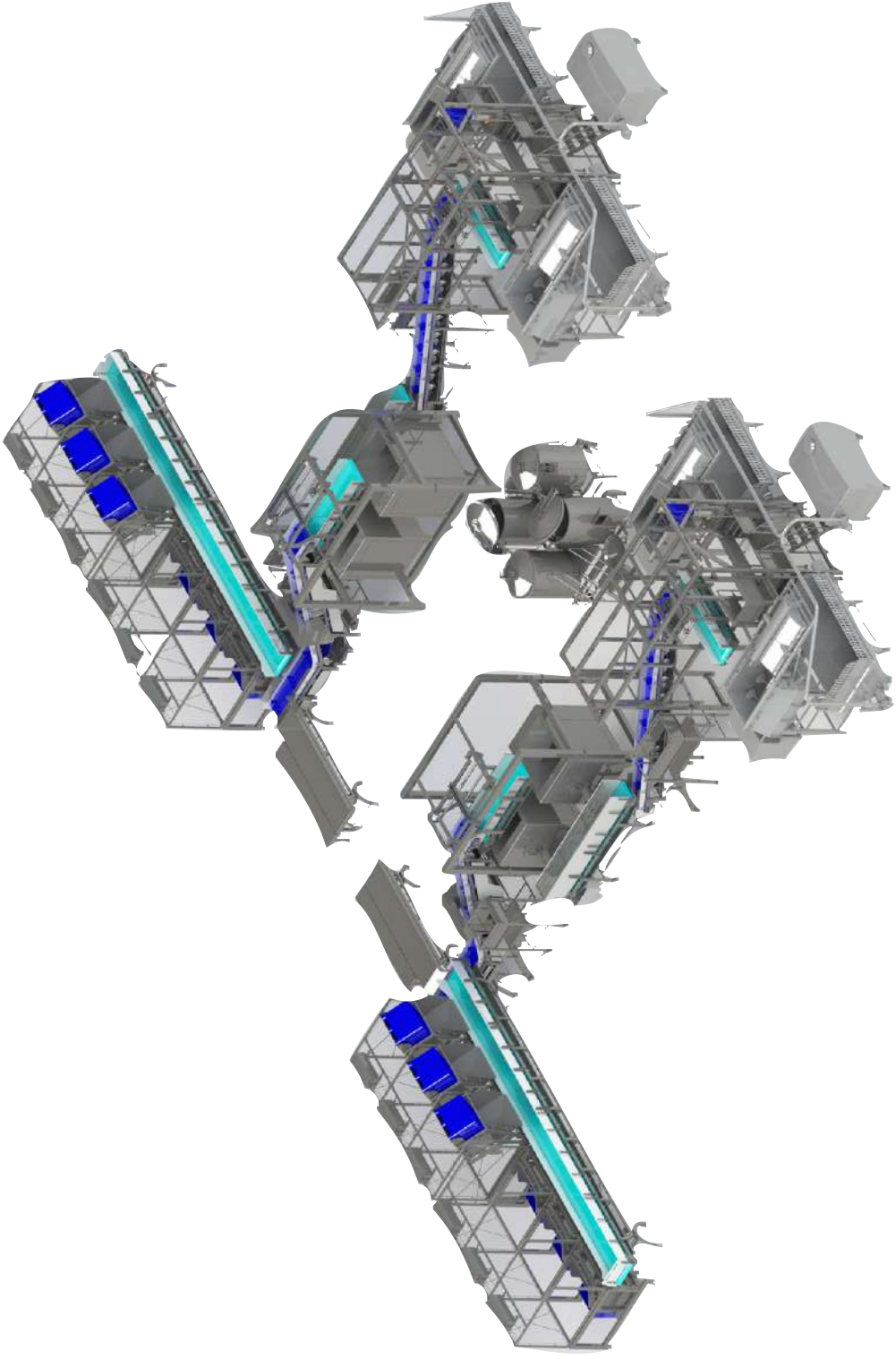

## STANDARD LINE 3

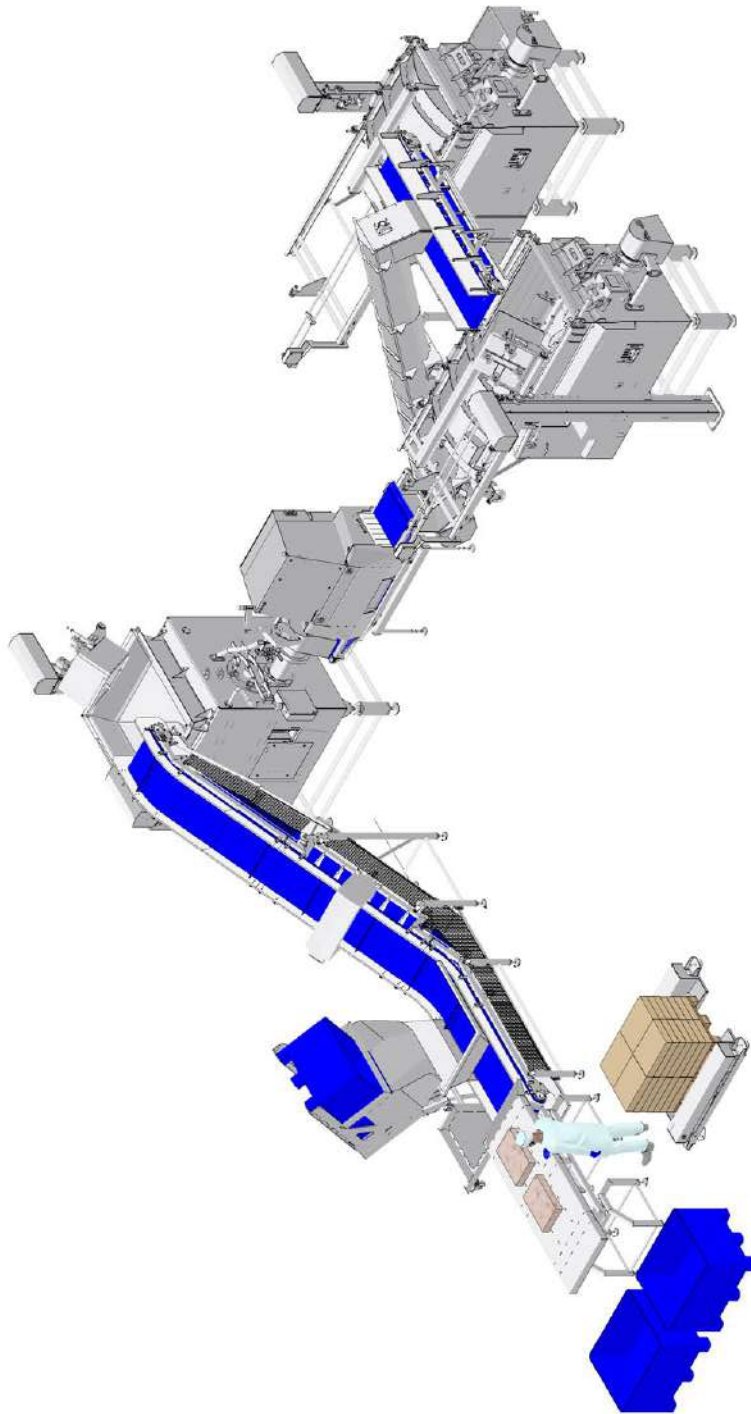

## STANDARD LINE 4

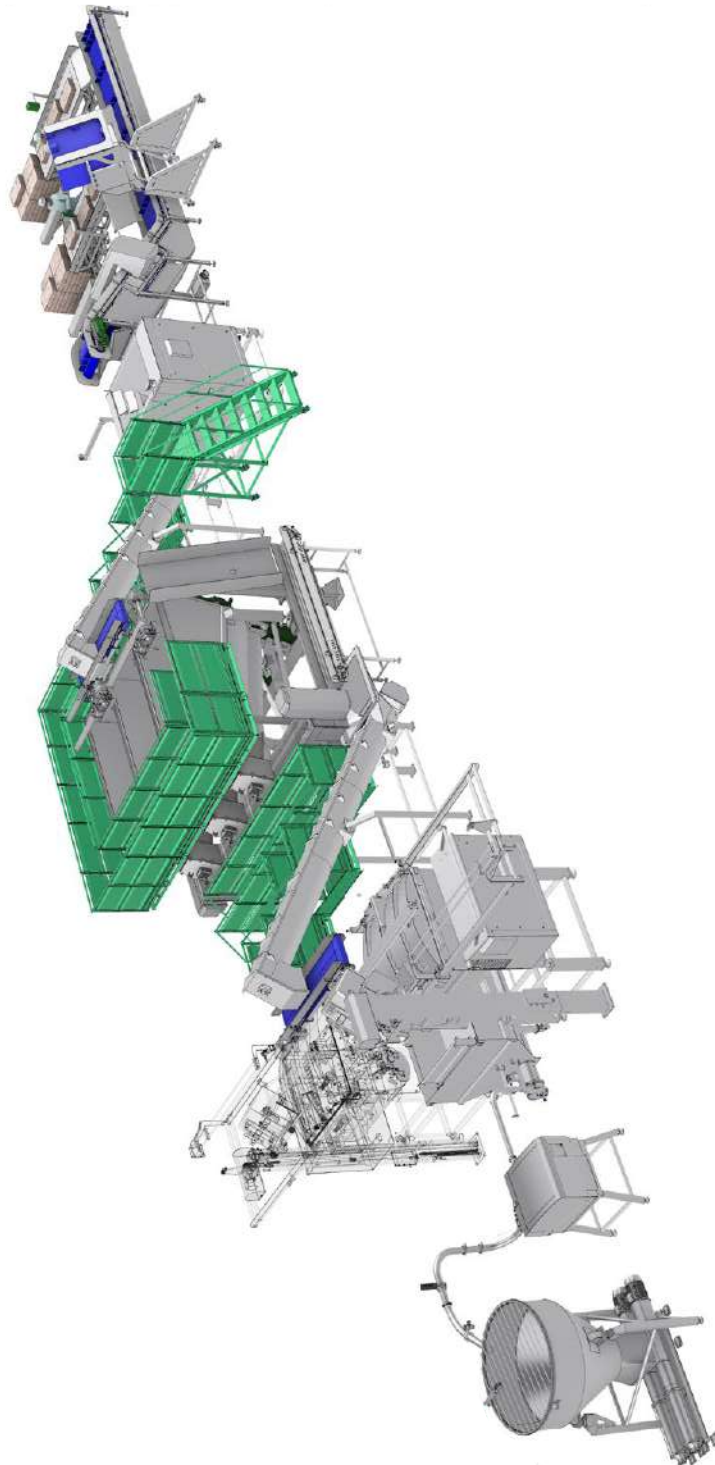

# Our Global Agents & Distributors

**HIGHLIGHTED BLUE AREAS SHOW GEOGRAPHIC LOCATION OF scansteel foodtech<sup>®</sup> AGENTS AND DISTRIBUTORS.**

**27 AGENTS & DISTRIBUTORS**

**SPREAD OVER 6 CONTINENTS**

**ACTIVE IN 55 COUNTRIES**

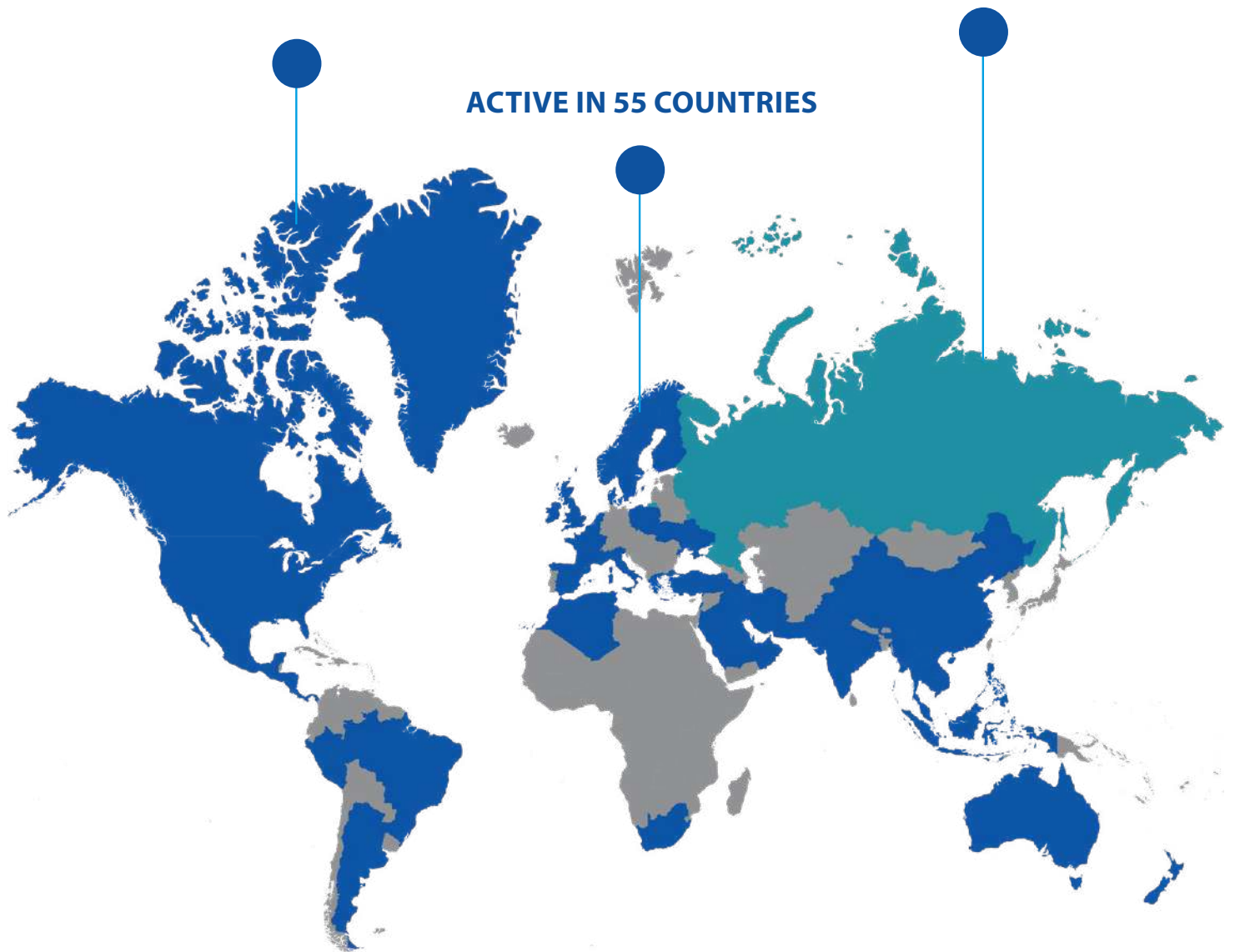

# Our Global Agents & Distributors

## Australia



Jamie Culpitt  
Mobile: +61 432 605 627  
E-mail: jamie@focustrading.com.au  
Website: www.focustrading.com.au

Darryl Russ  
Mobile: +61 459 261 052  
E-mail: darryl@focustrading.com.au

## Algeria



Tobias Marc Madsen  
Mobile: +45 31 43 09 06  
E-mail: tobias.madsen@scansteelfoodtech.com

## Argentina



Maximiliano Vigliola  
Mobile: +54 911 40515947

## Bahrain



Philip K. Koshy  
Mobile: +971 (0)56 535 4849  
E-mail: ceo@fpt-me.com  
Website: www.fpt-me.com

Babu Puthoor  
Mobile: +971 (0)54 447 4163  
E-mail: pm@fpt-me.com

## Belgium



Harry Jorissen  
Mobile: +31 (0) 6 11867762  
E-mail: harry@vertec.nl  
Website: www.vertec.nl

## Brazil



Antonio Carlos Filleti  
Mobile: +55 11 98331-0887  
E-mail: antonio.filleti@fimach.com.br  
Website: www.fimach.com.br

## Cambodia



Axel Arras  
Mobile: +66 (0) 81927-4346  
E-mail: axel.arras@fpt-asia.com

Surarit Boonyapreddee (Yod)  
Mobile: +66 (0) 81-414-6667  
E-mail: sales.rep@fpt-asia.com

Website: fpt-asia.com

## Canada



Aaron Chabino  
Phone: +1 816-880-9321  
E-mail: achabino@scanamcorp.com  
Website: www.scanamcorp.com

Barry France  
Phone: +1 816-715-0165  
E-mail: bfrance@scanamcorp.com  
Website: www.scanamcorp.com

# Our Global Agents & Distributors

## China



Jane Zhu  
Mobile: +86-150 9528 4001  
E-mail: jane.zhu@h-plus.net

Peter Sun  
E-mail: peter.sun@h-plus.net

## Costa Rica



Pedro Vargas P.  
Telephone: +506 2430 4875  
Mobile: +506 8821 8487  
E-mail: pvargas@monitrolcr.com

## Denmark



Bjarne Hvolbøll  
Mobile: +45 20 31 38 65  
E-mail: bh@nemco.dk  
Website: www.nemco.dk

## El Salvador



Pedro Vargas P.  
Telephone: +506 2430 4875  
Mobile: +506 8821 8487  
E-mail: pvargas@monitrolcr.com

## Finland



Pertti Laurila  
E-mail: pla@nemco.fi  
Website: www.nemco.fi

Bjarne Hvolbøll  
Mobile: +45 20 31 38 65  
E-mail: bh@nemco.dk

## France



Vincent Lefebvre  
E-mail: v.lefebvre@bfrsystems.com  
Website: www.bfrsystems.com

## Greece



Evangelos Ioannides  
Mobile: +30 697 225 0701  
E-mail: evangelos.ioannides@iosd.gr  
Stergios Lentis  
Mobile: +30 698 116 7394  
E-mail: sales@iosd.gr

Vasilis Tsirikas  
Mobile: +30 697 339 8202  
E-mail: sales2@iosd.gr

## Greenland



Per Birkholm  
Mobile: +45 51 73 02 52  
E-mail: per.birkholm@scansteelfoodtech.com

# Our Global Agents & Distributors

## Guatemala



Pedro Vargas P.  
Telephone: +506 2430 4875  
Mobile: +506 8821 8487  
E-mail: pvargas@monitrolcr.com

## Honduras



Pedro Vargas P.  
Telephone: +506 2430 4875  
Mobile: +506 8821 8487  
E-mail: pvargas@monitrolcr.com

## Indonesia



Desmond Cheong  
Mobile: +65 8321 9233  
E-mail: pms@fpt-asia.com

Website: fpt-asia.com

## Ireland



Chris Keenan  
Mobile: +44 (0) 788 155 1420  
E-mail: ck@omori.eu  
Website: www.omori.eu

## Israel



Raz Pessach  
Mobile: +972 (0) 52 6440 318  
E-mail: raz@pessach.net  
Website: www.pessach.net

## Italy



Marco Alessandro Weiss  
Mobile: +39 059 460012  
E-mail: m.weiss@techpartnersrl.it  
Website: www.techpartnersrl.com

Andrea Gasparini  
Mobile: +39 327 2028094  
E-mail: a.gasparini@techpartnersrl.it

## Kuwait



Philip K. Koshy  
Mobile: +971 (0)56 535 4849  
E-mail: ceo@fpt-me.com  
Website: www.fpt-me.com

Babu Puthoor  
Mobile: +971 (0)54 447 4163  
E-mail: pm@fpt-me.com

## Laos



Axel Arras  
Mobile: +66 (0) 81927 4346  
E-mail: axel.arras@fpt-asia.com

Website: fpt-asia.com

Surarit Boonyapreddee (Yod)  
Mobile: +66 (0) 81-414-6667  
E-mail: sales.rep@fpt-asia.com



# Our Global Agents & Distributors

## Malaysia



Desmond Cheong  
Mobile: +65 8321 9233  
E-mail: pms@fpt-asia.com

Website: fpt-asia.com

## Mexico



Per Birkholm  
Mobile: +45 51 73 02 52  
E-mail: per.birkholm@scansteelfoodtech.com

## Morocco



Tobias Marc Madsen  
Mobile: +45 31 43 09 06  
E-mail: tobias.madsen@scansteelfoodtech.com

## Myanmar



Axel Arras  
Mobile: +66 (0) 81927 4346  
E-mail: axel. arras@fpt-asia.com

Surarit Boonyapredee (Yod)  
Mobile: +66 (0) 81-414-6667  
E-mail: sales.rep@fpt-asia.com

Website: fpt-asia.com

## Namibia



Per Birkholm  
Mobile: +45 51 73 02 52  
E-mail: per.birkholm@scansteelfoodtech.com

## The Netherlands



Harry Jorissen  
Mobile: +31 (0) 6 11867762  
E-mail: harry@vertec.nl  
Website: www.vertec.nl

## New Zealand



Sandie Hussey  
Telephone: +64 929 4023  
Email: sandie@foodmis.co.nz  
Website: www.foodmis.co.nz

## Nicaragua



Pedro Vargas P.  
Telephone: +506 2430 4875  
Mobile: +506 8821 8487  
E-mail: pvargas@monitrolcr.com

# Our Global Agents & Distributors

## Norway



Odd Breigutu  
Phone: +47 22 91 44 03  
E-mail: odd@bokken.no  
Website: www.bokken.no

## Oman



Philip K. Koshy  
Mobile: +971 (0)56 535 4849  
E-mail: ceo@fpt-me.com  
Website: www.fpt-me.com

Babu Puthoor  
Mobile: +971 (0)54 447 4163  
E-mail: pm@fpt-me.com

## Panama



Pedro Vargas P.  
Telephone: +506 2430 4875  
Mobile: +506 8821 8487  
E-mail: pvargas@monitrolcr.com

## Papau New Guinea



Jamie Culpitt  
Mobile: +61 432 605 627  
E-mail: jamie@focustrading.com.au  
Website: www.focustrading.com.au

## Peru



Per Birkholm  
Mobile: +45 51 73 02 52  
E-mail: per.birkholm@scansteelfoodtech.com

## Philippines



Melvin G. Nebria  
Mobile: +63917 863 5258  
E-mail: sm@fpt-ph.com  
Website: fpt-asia.com

## Poland



Marcin Królicki  
Mobile: +48 601 150 997  
E-mail: m.krolicki@premac.pl  
Website: www.premac.pl

## Qatar



Philip K. Koshy  
Mobile: +971 (0)56 535 4849  
E-mail: ceo@fpt-me.com  
Website: www.fpt-me.com

Babu Puthoor  
Mobile: +971 (0)54 447 4163  
E-mail: pm@fpt-me.com

# Our Global Agents & Distributors

## Russia



Alexander Bobrow  
E-mail: aab@foodpromtech.ru  
Website: www.foodpromtech.ru

**NOTE: ALL BUSINESS ACTIVITY ON HOLD**

## Saudi Arabia



Philip K. Koshy  
Mobile: +971 (0)56 535 4849  
E-mail: ceo@fpt-me.com  
Website: www.fpt-me.com

Babu Puthoor  
Mobile: +971 (0)54 447 4163  
E-mail: pm@fpt-me.com

## Singapore



Desmond Cheong  
Mobile: +65 8321 9233  
E-mail: pms@fpt-asia.com  
Website: fpt-asia.com

## South Africa



Per Birkholm  
Mobile: +45 51 73 02 52  
E-mail: per.birkholm@scansteelfoodtech.com

## Spain



Javier Lopez  
Mobile: +34 667 669 556  
E-mail: javier@picsl.es  
Website: www.picsl.es

Xevi López  
Mobile: +34 634 622 041  
E-mail: xevi@naxindustrias.es

## Sri Lanka



Leonard Edirisinghe  
Mobile: +94 (0) 77 8804125  
E-mail: sl@fpt-asia.com  
Website: fpt-asia.com

## Sweden



Peo Blomqvist  
Mobile: +46 (0)706 010 111  
E-mail: pb@nemco.se  
Website: www.nemco.se

## Thailand



Axel Arras  
Mobile: +66 (0) 81927-4346  
E-mail: axel.arras@fpt-asia.com  
Website: fpt-asia.com

Surarit Boonyapredeedee (Yod)  
Mobile: +66 (0) 81-414-6667  
E-mail: sales.rep@fpt-asia.com

# Our Global Agents & Distributors

## Tunisia



Tobias Marc Madsen  
Mobile: +45 31 43 09 06  
E-mail: tobias.madsen@scansteelfoodtech.com

## Türkiye



Bahadır Kabasakal  
Telephone: +90 532 737 19 29  
E-mail: bahadir@albateknik.com  
Website: www.albateknik.com

## Ukraine



Olexiy B. Kolodchenko  
Mobile: +38 067 5061112  
E-mail: olexiy@steiner.com.ua  
Website: www.steiner.com.ua

## United Arab Emirates



Philip K. Koshy  
Mobile: +971 (0)56 535 4849  
E-mail: ceo@fpt-me.com  
Website: www.fpt-asia.com

Babu Puthoor  
Mobile: +971 (0)54 447 4163  
E-mail: pm@fpt-me.com

## United Kingdom



Chris Keenan  
Mobile: +44 (0) 788 155 1420  
E-mail: ck@omori.eu  
Website: www.omori.eu

## USA



Aaron Chabino  
Phone: +1 816-880 9321  
E-mail: achabino@scanamcorp.com  
Website: www.scanamcorp.com

Barry France  
Phone: +1 816-715-0165  
E-mail: bfrance@scanamcorp.com  
Website: www.scanamcorp.com

## Vietnam



Nguyen Ngoc Duong  
Mobile: +84(0) 907 054 786  
E-mail: cmo.vn@fpt-asia.com  
Website: www.fpt-asia.com

QuadrocutVac 225 - TemBi



QuadrocutVac 225

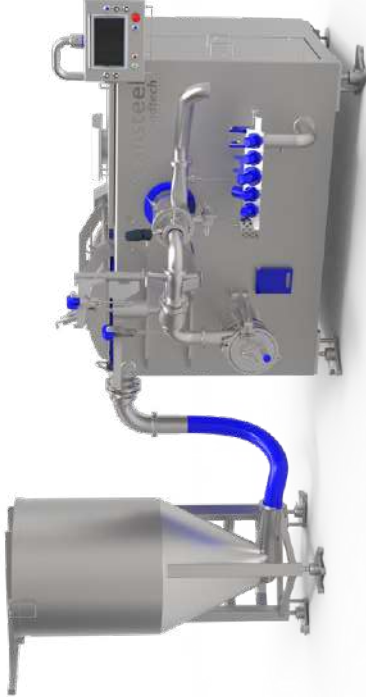

Quadrocut 225



scanEmul 175 - Pump fed



scanEmul 175 - Screw hopper fed



scanEmul 175 - Hopper fed



# Customer Notes

---



10,450 m<sup>2</sup> factory in Denmark, Headquarters of: scansteel foodtech A/S & Koncept Tech ApS



March 2024 Edition

## Follow us on Social Media



scansteel foodtech



scansteel foodtech A/S



scansteel foodtech

**scansteel foodtech A/S**

Industrivej 6  
4200 Slagelse  
Denmark

Phone: +45 7027 1410

Fax: +45 7027 1411

[www.scansteelfoodtech.com](http://www.scansteelfoodtech.com)